

# Centre for Archaeological Fieldwork

School of Geography, Archaeology and Palaeoecology, QUB

**CAF Data Structure Report: No. 111**

**Excavations at Dunluce Castle, Co. Antrim**

Andrew Gault and Grace McAlister

**VOLUME 3: APPENDICES**

ANT 002:003 & ANT 002:008



On behalf of





## **EXCAVATIONS AT DUNLUCE CASTLE, CO. ANTRIM**

Excavations carried out on behalf of  
The Northern Ireland Environment Agency (NIEA): Built Heritage

**Directed by Andrew Gault and Grace McAlister**

Report by

***Grace McAlister***

*gmcAlister02@qub.ac.uk*

The Centre for Archaeological Fieldwork  
School of Geography, Archaeology and Palaeoecology  
Queen's University  
Belfast, BT7 1NN

CAF Data Structure Report No. 111

SMR: ANT002:003 and ANT 002:008

Excavation Licence: AE/14/78

*30<sup>th</sup> October 2014*

**VOLUME 3: APPENDICES**

## **CONTENTS**

### **VOLUME 3**

|             |                       |    |
|-------------|-----------------------|----|
| APPENDIX 1: | Context Register      | 1  |
| APPENDIX 2: | Harris Matrices       | 12 |
| APPENDIX 3: | Drawing Register      | 45 |
| APPENDIX 4: | Photographic Register | 53 |
| APPENDIX 5: | Sample Register       | 80 |
| APPENDIX 6: | Finds Register        | 82 |

## APPENDIX 1: CONTEXT REGISTERS

### Area C

| Context No. | Type  | Trench | Brief description |
|-------------|-------|--------|-------------------|
| 100         | Layer | 1      | Sod               |
| 101         | Layer | 1      | Topsoil           |
| 102         | Layer | 1      | Slate layer       |
| 103         | Layer | 1      | Cobbles           |

| Context No. | Type  | Trench | Brief description |
|-------------|-------|--------|-------------------|
| 200         | Layer | 2      | Sod               |
| 201         | Layer | 2      | Topsoil           |
| 202         | Layer | 2      | Slate Layer       |
| 203         | Layer | 2      | Cobbles           |

| Context No. | Type  | Trench | Brief description |
|-------------|-------|--------|-------------------|
| 400         | Layer | 4      | Sod               |
| 401         | Layer | 4      | Topsoil           |
| 402         | Layer | 4      | Cobbled surface   |

### Area D

| Context No. | Type  | Trench | Brief description    |
|-------------|-------|--------|----------------------|
| 500         | Layer | 5      | Sod                  |
| 501         | Layer | 5      | Cobbles              |
| 502         | Layer | 5      | Dark, disturbed soil |

| Context No. | Type    | Trench | Brief description   |
|-------------|---------|--------|---------------------|
| 2900        | Layer   | 29     | Sod/topsoil         |
| 2901        | Layer   | 29     | Redeposited topsoil |
| 2902        | Layer   | 29     | Buried topsoil      |
| 2903        | Natural | 29     | Bedrock             |

## Area E

| Context No. | Type    | Trench | Brief description  |
|-------------|---------|--------|--|
| 2600        | Layer   | 26A,B  | Sod  |
| 2601        | Layer   | 26A,B  | Topsoil  |
| 2602        | Layer   | 26A    | Stone layer at south of trench                                     |
| 2603        | Layer   | 26B    | Angular stones/rubble material                                     |
| 2604        | Layer   | 26A    | Burnt deposit, north of trench                                     |
| 2605        | Layer   | 26A    | Silty soil running under C.2604                                    |
| 2606        | Layer   | 26A    | Bedrock  |
| 2607        | Layer   | 26A    | Burnt deposit under C.2604, north of trench                        |
| 2608        | Wall    | 26B    | Wall in north-west of trench                                       |
| 2609        | Wall    | 26B    | Wall in east of trench   |
| 2610        | Layer   | 26B    | Dark brown silty loam with ash and charcoal flecks                 |
| 2611        | Layer   | 26B    | Metalled/stony deposit in south-west interior corner               |
| 2612        | Layer   | 26B    | Angular stones/rubble material                                     |
| 2613        | Layer   | 26B    | Brown loam with orange, and large charcoal and ash flecks          |
| 2614        | Layer   | 26B    | Sub-angular/rounded stones running west-east in trench (Threshold) |
| 2615        | Layer   | 26B    | Possible occupation layer with patch of burning                    |
| 2616        | Layer   | 26B    | Possible beaten clay floor in threshold of building                |
| 2617        | Layer   | 26B    | Possible hearth in C.2615  |
| 2618        | Layer   | 26B    | Possible natural subsoil in west of trench                         |
| 2619        | Masonry | 26B    | Foundation stones for 2608   |

## Area G

| Context No. | Type    | Trench | Brief description   |
|-------------|---------|--------|---|
| 700         | Layer   | 7      | Sod   |
| 701         | Layer   | 7      | Topsoil   |
| 702         | Deposit | 7      | Deposit of stones, possible wall collapse                                     |
| 703         | Wall    | 7      | Deposit of stones, possible wall  |
| 704         | Layer   | 7      | Grey-brown gritty loam  |
| 705         | Layer   | 7      | Orangey-brown clay, possible bank natural                                     |
| 706         | Layer   | 7      | Orangey-brown clay, possible redeposit for terrace                            |
| 707         | Layer   | 7      | Grey-brown clay loam, buried soil horizon onto which wall has been built      |
| 708         | Cut     | 7      | Foundation cut for wall (703) through 706 and 707                             |
| 709         | Layer   | 7      | Deposit of small stones on surface of 707, possibly from construction of wall |
| 710         | Fill    | 7      | Grey-brown clay loam used to fill cut between wall and 706                    |
| 711         | Layer   | 7      | Orange-brown mottled clay, used for terrace                                   |
| 712         | Fill    | 7      | Fill of gully 713, cut into subsoil, close to wall                            |
| 713         | Cut     | 7      | Gully cut into subsoil, close to wall   |
| 714         | Fill    | 7      | Fill of gully 715   |
| 715         | Cut     | 7      | Gully cut into subsoil in north of trench                                     |
| 716         | Layer   | 7      | Subsoil   |
| 717         | Fill    | 7      | Fill of 718   |
| 718         | Cut     | 7      | Cut into subsoil, north end of trench   |
| 719         | Layer   | 7      | Deposit of stones sitting in subsoil in north of trench                       |

| Context No. | Type    | Trench | Brief description   |
|-------------|---------|--------|---|
| 800         | Layer   | 8      | Sod   |
| 801         | Layer   | 8      | Topsoil   |
| 802         | Deposit | 8      | Deposit of large stones covering trench, some cut natural |
| 803         | Layer   | 8      | Grey-brown gritty loam surrounding 802                    |
| 804         | Layer   | 8      | Mid-brown clay that 802 sits on                           |
| 805         | Layer   | 8      | Orange-brown clay   |
| 806         | Layer   | 8      | Subsoil   |

| Context No. | Type    | Trench | Brief description  |
|-------------|---------|--------|--|
| 900         | Layer   | 9b     | Sod  |
| 901         | Layer   | 9b     | Topsoil  |
| 902         | Layer   | 9b     | Small deposit that has accumulated between 906 and 907 on top of 909           |
| 903         | Wall    | 9b     | Wall in south of trench  |
| 904         | Layer   | 9b     | Orange-brown stony clay, terrace deposit                                       |
| 905         | Wall    | 9b     | Mortar-rich wall in north of trench  |
| 906         | Layer   | 9b     | Stone collapse sitting on 902, most likely from 903                            |
| 907         | Layer   | 9b     | Mortar-rich collapse in north of trench, likely from 905                       |
| 908         | Layer   | 9b     | Grey-brown mortar flecked loam onto which 905 has collapsed in north of trench |
| 909         | Layer   | 9b     | Possible path  |
| 910         | Deposit | 9b     | Deposit on which path sits, between walls                                      |
| 911         | Layer   | 9b     | Mid-dark brown terrace material under 904                                      |
| 912         | Layer   | 9b     | Stone chippings/working surface for construction of 903                        |
| 913         | Deposit | 9b     | Charcoal deposit beneath 908 in north of trench, mottled with 919              |
| 914         | Fill    | 9b     | Grey clay, fill of foundation cut for wall 905                                 |
| 915         | Cut     | 9b     | Cut for wall 905   |
| 916         | Layer   | 9b     | Orange gritty clay south of 905  |
| 917         | Layer   | 9b     | Charcoal deposit associated with 916, south of 905                             |
| 918         | Layer   | 9b     | Old topsoil that terraces are built on   |
| 919         | Layer   | 9b     | Orange gritty clay, mottled with 913, north of 905                             |
| 920         | Layer   | 9b     | Old ground topsoil between walls 905 and 903                                   |
| 921         | Layer   | 9b     | Accumulation of charcoal-flecked soil above charcoal deposit 917               |
| 922         | Layer   | 9b     | Small spread of mortar on top of 921, from construction of wall 905            |
| 923         | Layer   | 9b     | Hill-wash deposit covering 913 and 919 north of wall, same as 921              |
| 924         | Layer   | 9a     | Sod  |
| 925         | Layer   | 9a     | Topsoil  |
| 926         | Layer   | 9a     | Large rubble and mortar collapse   |
| 927         | Layer   | 9a     | Loamy soil with brick, shell and pebble flecking, under 926, east of wall      |
| 928         | Masonry | 9a     | Wall   |
| 929         | Layer   | 9a     | Stony, mortar collapse layer, west of wall                                     |
| 930         | Layer   | 9a     | Mortar/render layer  |
| 931         | Layer   | 9a     | Topsoil layer with stony flecking, at west of trench                           |
| 932         | Layer   | 9a     | Linear arrangement of large causeway stones                                    |
| 933         | Layer   | 9a     | Soil, loamy layer under pathway, east of wall                                  |
| 934         | Layer   | 9a     | Working surface east of wall   |
| 935         | Layer   | 9a     | Loamy clay under 934   |
| 936         | Surface | 9a     | Crushed brick path   |
| 937         | Fill    | 9a     | Dark-brown charcoal-flecked clay-loam, west of 932                             |
| 938         | Fill    | 9a     | Dark-brown clay-loam, north of trench, west of 932                             |

|     |       |    |   |
|-----|-------|----|---|
| 939 | Fill  | 9a | Very dark charcoal-flecked loamy clay, south of trench, west of 932 |
| 940 | Cut   | 9a | Cut for wall, west of wall  |
| 941 | Fill  | 9a | Dark brown clay, fill of cut 940                                    |
| 942 | Cut   | 9a | Cut of 937 at base of feature 932                                   |
| 943 | Cut   | 9a | Dark brown, loamy fill of 939                                       |
| 944 | Cut   | 9a | Dark brown, loamy clay, fill of 938                                 |
| 945 | Layer | 9a | Original topsoil above natural                                      |
| 946 | Cut   | 9a | Cut for wall, east of wall  |
| 947 | Fill  | 9a | Dark brown clay, fill of cut 946,                                   |
| 948 | Fill  | 9a | Fill of drain 932   |
| 948 | layer | 9b | Silty clay under burning 917  |

| Context No. | Type  | Trench | Brief description                                 |
|-------------|-------|--------|---|
| 1000        | Layer | 10     | Sod   |
| 1001        | Layer | 10     | Topsoil   |
| 1002        | Layer | 10     | Redeposit (garden level?)                         |
| 1003        | Layer | 10     | Collapse slate over 1002                          |
| 1004        | Layer | 10     | Black organic soft loam silt                      |
| 1005        | Layer | 10     | Compact grey-orange clay (possibly pre-17th)      |
| 1006        | Layer | 10     | Chalk layer under 1004                            |
| 1007        | Layer | 10     | Greyish-brown sticky, firm, clay with animal bone |
| 1008        | Layer | 10     | Natural bedrock                                   |
| 1009        | Cut   | 10     | Cut for ditch or pit through 1005                 |
| 1010        |       |        | VOID  |
| 1011        | Layer | 10     | Light grey loam                                   |

| Context No. | Type  | Trench | Brief description                 |
|-------------|-------|--------|-----------------------------------|
| 1100        | Layer | 11     | Sod                               |
| 1101        | Layer | 11     | Topsoil                           |
| 1102        | Layer | 11     | Building rubble                   |
| 1103        | Layer | 11     | Buried soil - garden              |
| 1104        | Cut   | 11     | Cut of gully                      |
| 1105        | Fill  | 11     | Fill of gully                     |
| 1106        | Layer | 11     | Natural (redeposited)             |
| 1107        | Cut   | 11     | Cut of gully                      |
| 1108        | Fill  | 11     | Fill of gully                     |
| 1109        | Layer | 11     | Redeposited material (slippage)   |
| 1110        | Layer | 11     | Buried topsoil layer (pre-garden) |
| 1111        | Layer | 11     | Topsoil over pathway              |
| 1112        | Layer | 11     | Natural                           |
| 1113        | Cut   | 11     | Cut to west of trench             |

| Context No. | Type  | Trench | Brief description              |
|-------------|-------|--------|--------------------------------|
| 1200        | Layer | 12     | Sod                            |
| 1201        | Layer | 12     | Slate, rubble                  |
| 1202        | Layer | 12     | Loam                           |
| 1203        | Layer | 12     | Render layer                   |
| 1204        | Layer | 12     | Slate and stone in gritty loam |
| 1205        | Layer | 12     | Slate deposit                  |

|      |         |    |   |
|------|---------|----|---|
| 1206 | Layer   | 12 | Level area of redeposited subsoil                     |
| 1207 | Fill    | 12 | Loam fill of cut 1209                                 |
| 1208 | Feature | 12 | Wall  |
| 1209 | Cut     | 12 | Possible drain filled by 1207                         |
| 1210 | Layer   | 12 | Probable subsoil                                      |
| 1211 | Masonry | 12 | Wall abutted to 1208                                  |
| 1212 | Fill    | 12 | Stone fill of probable drain 1213                     |
| 1213 | Cut     | 12 | Cut for possible drain under 1211                     |
| 1214 | Layer   | 12 | Accumulation of material under 1212, backfill of 1213 |
| 1215 | Cut     | 12 | Cut for small stakehole in far north corner of trench |
| 1216 | Fill    | 12 | Fill of 1215  |
| 1217 | Layer   | 12 | Dark layer under 1206                                 |
| 1218 | Fill    | 12 | Silty fill of drain (1213) voids                      |

| Context No. | Type    | Trench | Brief description                                   |
|-------------|---------|--------|---|
| 1300        | Layer   | 13b    | Sod   |
| 1301        | Layer   | 13b    | Topsoil (silty loam)                                |
| 1302        | Layer   | 13b    | Rubble deposit with mortar inclusions               |
| 1303        | Layer   | 13b    | Grey-brown mottled clay loam                        |
| 1304        | Layer   | 13b    | Shallow gravelly deposit                            |
| 1305        | Layer   | 13b    | Yellow-orange clay deposit                          |
| 1306        |         |        | VOID  |
| 1307        | Wall    | 13b    | Masonry - garden wall                               |
| 1308        | Layer   | 13b    | Yellow clay   |
| 1309        | Layer   | 13b    | Dark deposit, possibly buried topsoil horizon       |
| 1310        | Layer   | 13b    | Bank material behind wall                           |
| 1311        | Cut     | 13b    | Cut of wall foundation trench                       |
| 1312        | Fill    | 13b    | Fill of foundation trench                           |
| 1313        | Cut     | 13b    | Cut of terracing                                    |
| 1314        | Layer   | 13a    | Building rubble                                     |
| 1315        | Masonry | 13a    | Wall  |
| 1316        | Layer   | 13a    | Garden soil/backfill                                |
| 1317        | Layer   | 13a    | Brown deposit                                       |
| 1318        | Layer   | 13a    | Yellow-orange clay deposit                          |
| 1319        | Layer   | 13a    | Dark deposit, possibly buried topsoil               |
| 1320        | Layer   | 13a    | Gravel layer, possibly levelling surface or path    |
| 1321        | Layer   | 13a    | Brown clay loam deposit underlying gravel           |
| 1322        | Cut     | 13a    | Slot trench (west face of wall)                     |
| 1323        | Layer   | 13a    | Fill of slot trench                                 |
| 1324        | Cut     | 13a    | Cut of possible pit                                 |
| 1325        | Fill    | 13a    | Fill of pit feature                                 |
| 1326        | Layer   | 13a    | Natural   |
| 1327        | Wall    | 13a    | Lower wall orientated E-W, extension of trench 13a  |
| 1328        | Layer   | 13a    | Spread of rubble north of wall                      |
| 1329        | Fill    | 13a    | Fill of 1330  |
| 1330        | Cut     | 13a    | Linear cut in northern extension of 13a, below 1328 |
| 1331        | Wall    | 13a    | Masonry - garden wall (similar to 1307 in Tr. 13b)  |

| Context No. | Type  | Trench | Brief description |
|-------------|-------|--------|-------------------|
| 1400        | Layer | 14     | Sod               |



|      |           |    |   |
|------|-----------|----|---|
| 1401 | Layer     | 14 | Topsoil                                 |
| 1402 | Layer     | 14 | Stony deposit with flint and burning    |
| 1403 | Structure | 14 | Possible stone wall or drain            |
| 1404 | Layer     | 14 | Gritty clay, east side of 1403          |
| 1405 | Layer     | 14 | Gritty, mottled clay, west side of 1403 |
| 1406 | Layer     | 14 | Smooth clay, under 1404                 |
| 1407 | Layer     | 14 | Degraded stone                          |
| 1408 | Layer     | 14 | Possible natural, under 1406            |

| Context No. | Type  | Trench | Brief description                      |
|-------------|-------|--------|--|
| 1500        | Layer | 15a+b  | Sod                                    |
| 1501        | Layer | 15a+b  | Topsoil                                |
| 1502        | Layer | 15b    | Garden soil                            |
| 1503        | Layer | 15b    | Yellow clay - possible subsoil         |
| 1504        | Layer | 15a    | Bank-like deposit with lime and stones |
| 1505        | Layer | 15a    | Stone deposit                          |
| 1506        | Fill  | 15a    | Fill of drain/gully                    |
| 1507        | Cut   | 15a    | Cut of drain/gully                     |
| 1508        | Cut   | 15a    | Cut of linear                          |
| 1509        | Fill  | 15a    | Fill of linear                         |
| 1510        | Layer | 15a    | Stone deposit at west end of trench    |

| Context No. | Type  | Trench | Brief description  |
|-------------|-------|--------|--|
| 1600        | Layer | 16     | Sod  |
| 1601        | Layer | 16     | Mid-brown topsoil in south of trench                                       |
| 1602        | Layer | 16     | Light brown topsoil in north of trench                                     |
| 1603        | Layer | 16     | Gritty, silty loam in extreme south end of trench                          |
| 1604        | Layer | 16     | Cobbled surface  |
| 1605        | Layer | 16     | Stony rubble material on south side of wall                                |
| 1606        | Layer | 16     | Stony rubble material on north side of wall                                |
| 1607        | Wall  | 16     | Wall marking the furthest northern extent of cobbles 1604                  |
| 1608        | Layer | 16     | Mid-brown clay loam in north end of trench                                 |
| 1609        | Layer | 16     | Yellow-brown sandy clay in north end of trench - subsoil                   |
| 1610        | Cut   | 16     | Cut for slot trench, fill 1611   |
| 1611        | Layer | 16     | Fill for slot trench, cut 1610   |
| 1612        | Layer | 16     | In-situ bank material in southern end of trench                            |
| 1613        | Cut   | 16     | Cut into subsoil into which the cobbles are laid                           |
| 1614        | Layer | 16     | Sandy orange-brown clay, natural subsoil                                   |
| 1615        | Layer | 16     | Basal layer above subsoil 16614  |
| 1616        | Layer | 16     | Layer of slip from bank, large stones represent possible revetment to bank |
| 1617        |       |        | VOID   |
| 1618        | Layer | 16     | Bank deposit   |
| 1619        | Layer | 16     | Bank deposit   |
| 1620        | Layer | 16     | Silty loam into which the cobbles 1604 are pressed, fill of cut 1613       |
| 1621        | Layer | 16     | Fill of pit  |
| 1622        | Layer | 16     | Ashy deposit   |
| 1623        | Layer | 16     | Basal fill of possible pit   |
| 1624        | Cut   | 16     | Cut for possible pit behind bank, filled by 1621, 1622, 1623               |

| Context No. | Type    | Trench | Brief description                                    |
|-------------|---------|--------|--|
| 1700        | Layer   | 17     | Sod  |
| 1701        | Layer   | 17     | Topsoil  |
| 1702        | Layer   | 17     | Mortary deposit in middle of trench                  |
| 1703        | Layer   | 17     | Rubble, brick demolition material                    |
| 1704        | Layer   | 17     | Garden soil - also fill of 1706                      |
| 1705        | Layer   | 17     | Level deposit of brick and stone, east end of trench |
| 1706        | Cut     | 17     | Gully cut, filled by 1707, cuts through 1704         |
| 1707        | Fill    | 17     | Brick deposit within gully                           |
| 1708        | Layer   | 17     | Foundation/consolidation material under 1709         |
| 1709        | Masonry | 17     | Large stones forming apparent threshold of doorway   |
| 1710        | Layer   | 17     | Lower demolition material containing slate           |
| 1711        | Layer   | 17     | Natural  |

#### Area T

| Context No. | Type  | Trench | Brief description   |
|-------------|-------|--------|---|
| 2000        | Layer | 20     | Sod layer   |
| 2001        | Layer | 20     | Upper layer of bank? Gravelly silty loam, lots of limestone, brick, etc.    |
| 2002        | Layer | 20     | Possible reveting stones  |
| 2003        | Layer | 20     | Topsoil, like garden soil?  |
| 2004        | Layer | 20     | Yellow-brown, gravelly layer in west end of trench                          |
| 2005        | Layer | 20     | Orange-brown silty loam, below C.2004                                       |
| 2006        | Layer | 20     | Yellow-brown matrix, with stones. Possible metallised surface, below C.2003 |
| 2007        | Layer | 20     | Gravelly layer. Mid brown silty loam matrix, in east of trench              |
| 2008        | Layer | 20     | Mid brown silty loam, below C.2007 (physically)                             |
| 2009        | Layer | 20     | Silty loam with small to medium stones in middle of trench                  |
| 2010        | Layer | 20     | Mid to dark brown silty loam, in west of trench, below C.2005 (physically)  |
| 2011        | Fill  | 20     | Light brown silty loam, with small to medium stones, similar to C.2009      |
| 2012        | Fill  | 20     | Basal fill of drain, directly below C.2011                                  |
| 2013        | Cut   | 20     | Cut for drain, filled by C.2011 and C.2012                                  |
| 2014        | Cut   | 20     | Natural subsoil   |
| 2015        | Fill  | 20     | Stones lining drain   |
| 2016        | Fill  | 20     | Fill for slot trench  |
| 2017        | Cut   | 20     | Basal fill of drain, directly below C.2016                                  |

| Context No. | Type  | Trench | Brief description                      |
|-------------|-------|--------|--|
| 2100        | Layer | 21     | Sod                                    |
| 2101        | Layer | 21     | Topsoil                                |
| 2102        | Layer | 21     | Cobbles                                |
| 2103        | Layer | 21     | Sub-soil layer                         |
| 2104        | Layer | 21     | Soil/charcoal layer under cobble layer |

| Context No. | Type    | Trench | Brief description                                       |
|-------------|---------|--------|---|
| 2200        | Layer   | 22A,B  | Sod   |
| 2201        | Layer   | 22A,B  | Topsoil   |
| 2202        | Lens    | 22B    | Lens within C.2203, north-west corner                   |
| 2203        | Layer   | 22B    |   |
| 2204        | Layer   | 22B    | Gravelly Layer, east of trench                          |
| 2205        | Layer   | 22A    | Stonier topsoil   |
| 2206        | Layer   | 22A    | Similar to 2205 but less gravelly, north end of trench  |
| 2207        | Layer   | 22A    | Confined area of redeposited subsoil                    |
| 2208        | Layer   | 22A    | Greyish brown silty clay over C.2209                    |
| 2209        | Layer   | 22A    | Greyish brown silty clay with blackish/organic mottling |
| 2210        | Layer   | 22B    | Clayey loam with orange clay lens                       |
| 2211        | Surface | 22B    | Possible metallated surface                             |
| 2212        | Layer   | 22A    | Blackish/brown mottled layer, organic                   |
| 2213        | Fill    | 22A    | Blackish, organic fill. Sampled under 2212              |
| 2214        | Layer   | 22C    | Sod   |
| 2215        | Layer   | 22C    | Topsoil   |
| 2216        | Cut     | 22A    | Cut for C.2209, south end of trench filled by C.2209    |
| 2217        | Layer   | 22B    | Stoney, mottled black and grey layer under C.2211       |
| 2218        | Layer   | 22C    | Black lens under topsoil                                |
| 2219        | Layer   | 22C    | Stoney layer under topsoil                              |
| 2220        | Fill    | 22A    | Fill of cut at north end of trench                      |
| 2221        | Cut     | 22A    | Cut at north end of trench                              |
| 2222        | Layer   | 22A    | Burnt layer under C.2220                                |
| 2223        | Fill    | 22A    | Fill of cut C.2224                                      |
| 2224        | Cut     | 22A    | Cut for hole  |
| 2225        | Layer   | 22B    | Silty soft layer above natural                          |
| 2226        | Layer   | 22B    | Mottled black and grey layer under C.2211               |
| 2227        | Deposit |        | Subsoil   |

| Context No. | Type    | Trench | Brief description                       |
|-------------|---------|--------|---|
| 2300        | Layer   | 23C    | Sod                                     |
| 2301        | Layer   | 23C    | Rubble/wall collapse (interior)         |
| 2302        | Feature | 23C    | Wall                                    |
| 2303        | Layer   | 23C    | Wall collapse (exterior)                |
| 2304        | Layer   | 23C    | Brown clay layer                        |
| 2305        | Layer   | 23C    | Dark brown-black layer beneath collapse |
| 2306        | Cut     | 23C    | Cut of post-hole                        |
| 2307        | Fill    | 23C    | Fill of post-hole                       |
| 2308        | Cut     | 23C    | Cut of post-hole                        |
| 2309        | Fill    | 23C    | Fill of post-hole                       |
| 2310        | Cut     | 23C    | Cut of irregular cut/gully              |
| 2311        | Fill    | 23C    | Fill of C.2310                          |
| 2312        | Layer   | 23A,B  | Rubble collapse                         |
| 2313        | Layer   | 23B    | Topsoil/silting below rubble            |
| 2314        | Layer   | 23B    | Cobbled surface                         |
| 2315        | Layer   | 23B    | Layer of collapse next to wall          |
| 2316        | Layer   | 23B    | Possible walls                          |
| 2317        | Layer   | 23B    | Collapse of roof slate                  |

|      |           |     |   |
|------|-----------|-----|---|
| 2318 | Layer     | 23B | Layer under cobbles                       |
| 2319 | Natural   |     | Natural                                   |
| 2320 | Layer     | 23D | Sod                                       |
| 2321 | Layer     | 23D | Collapse material                         |
| 2322 | Feature   | 23D | Level path surface                        |
| 2323 | Layer     | 23D | Intensely burnt clay layer                |
| 2324 | Layer     | 23D | Natural                                   |
| 2325 | Cut       | 23D | Containing fill C.2323                    |
| 2326 | Structure | 23B | Surface drain constructed of cobble       |
| 2327 | Layer     | 23B | Possible medieval topsoil horizon         |
| 2328 | Layer     | 23B | Sandy loam below C.2327                   |
| 2329 | Cut       | 23B | Modern truncation                         |
| 2330 | Fill      | 23B | Fill of truncation                        |
| 2331 | Layer     | 23A | Mortar rich rubble                        |
| 2332 | Layer     | 23A | Silty clay below demolition               |
| 2333 | Layer     | 23A | large stones (possible foundation stones) |
| 2334 | Layer     | 23B | Silty clay below C.2328                   |
| 2335 | Layer     | 23C | Topsoil                                   |

| Context No. | Type    | Trench | Brief description  |
|-------------|---------|--------|--|
| 2500        | Layer   | 25A    | Sod  |
| 2501        | Layer   | 25A    | Topsoil  |
| 2502        | Wall    | 25A    | Corner of house  |
| 2503        | Layer   | 25A    | Collapse from house inside building                                  |
| 2504        | Layer   | 25A    | Surface onto which house has collapsed                               |
| 2505        | Layer   | 25A    | Orange, burnt charcoal loam. Partially covering cobbles 2506         |
| 2506        | Layer   | 25A    | Cobbles outside house  |
| 2507        | Layer   | 25A    | Collapse from building outside house                                 |
| 2508        | Layer   | 25A    | Possible floor level beneath 2504                                    |
| 2509        | Layer   | 25B    | Sod  |
| 2510        | Layer   | 25B    | Topsoil  |
| 2511        | Layer   | 25B    | Rubble   |
| 2512        | Layer   | 25B    | Surface under collapse north of C.2511                               |
| 2513        | Layer   | 25A    | North-east corner - internal surface of house - possible feature     |
| 2514        | Layer   | 25B    | Surface onto which rubble has collapsed                              |
| 2515        | Layer   | 25B    | Surface onto which rubble has collapsed south of C.2511              |
| 2516        | Layer   | 25B    | Surface onto which rubble has collapsed south-west of C.2511         |
| 2517        | Wall?   | 25B    | Possible wall abutting C.2511  |
| 2518        | Layer   | 25B    | Layer of burnt charcoal loam (orange) under rubble C.2511            |
| 2519        | Layer   | 25B    | Stoney layer under C.2514  |
| 2520        | Wall    | 25B    | Wall running on an east-west alignment through middle of trench      |
| 2521        | Layer   | 25B    | Burnt deposit at south-east of trench                                |
| 2522        | Layer   | 25B    | Stoney deposit at south-east of trench                               |
| 2523        | Wall    | 25B    | Wall running north-south on east side of trench                      |
| 2524        | Wall?   | 25B    | Possible wall, continuation of C.2523 in south-east corner of trench |
| 2525        | Surface | 25B    | Metalled surface above natural C.2526 at north of trench             |
| 2526        | Natural | 25B    | Subsoil  |
| 2527        | Layer   | 25B    | Sandy grey despot under C.2515                                       |
| 2528        | Layer   | 25C    | External collapse  |
| 2529        | Layer   | 25C    | Internal collapse  |

|      |         |     |  |
|------|---------|-----|--|
| 2530 | Masonry | 25C | Wall   |
| 2531 | Layer   | 25C | Internal silty loamy clay  |
| 2532 | Layer   | 25C | External soil horizon, 17th Century                                      |
| 2533 | Cut     | 25C | Cut of gully   |
| 2534 | Fill    | 25C | Fill of gully  |
| 2535 | Surface | 25C | Possible cobbled interior surface  |
| 2536 | Lens    | 25C | Lens of burning under wall   |
| 2537 | Lens    | 25C | Lens of mortar under wall  |
| 2538 | Layer   | 25A | Clay floor in south-west corner of trench                                |
| 2539 | Wall?   | 25A | Stone plinth   |
| 2540 | Layer   | 25A | Deposit beneath 2513 in north-east corner of trench                      |
| 2541 | Layer   | 25A | Possible metallated surface, south-east corner outside house, below 2507 |
| 2542 | Wall    | 25A | Doorway, blocked up to from a continuous wall                            |

| Context No. | Type    | Trench | Brief description                   |
|-------------|---------|--------|-------------------------------------|
| 2700        | Layer   | 27     | Sod/topsoil                         |
| 2701        | Natural | 27     | Natural subsoil                     |
| 2702        | Layer   | 27     | Silting over stone surface          |
| 2703        | Layer   | 27     | Stone surface                       |
| 2704        | Layer   | 27     | Possible surface                    |
| 2705        | Layer   | 27     | Topsoil layer between 2703 and 2706 |
| 2706        | Layer   | 27     | Stone layer laid down south of 2703 |
| 2707        | Cut     | 27     | Cut of feature                      |
| 2708        | Fill    | 27     | Fill of cut                         |

| Context No. | Type  | Trench | Brief description                            |
|-------------|-------|--------|--|
| 2800        | Layer | 28     | Sod  |
| 2801        | Layer | 28     | Topsoil                                      |
| 2802        | Layer | 28     | Stone cobbles                                |
| 2803        | Layer | 28     | Stone cobbling                               |
| 2804        | Layer | 28     | Stone rubble                                 |
| 2805        | Layer | 28     | Soil layer under topsoil                     |
| 2806        | Fill  | 28     | Possible drain fill                          |
| 2807        | Layer | 28     | Same as 2801                                 |
| 2808        | Cut   | 28     | Cut of gully running north-south             |
| 2809        | Fill  | 28     | Fill of gully C.2808                         |
| 2810        | Cut   | 28     | Linear cut running north-west/south-east     |
| 2811        | Fill  | 28     | Fill of C.2810                               |
| 2812        | Fill  | 28     | Hardcore like surface over backfilled trench |
| 2813        | Cut   | 28     | Cut of secondary trench within C2810         |
| 2814        | Fill  | 28     | Ashy silty fill of C.2813                    |
| 2815        | Fill  | 28     | Redeposit clay                               |
| 2816        | Layer | 28     | Natural                                      |

| Context No. | Type    | Trench  | Brief description                           |
|-------------|---------|---------|---|
| 3000        | Layer   | 30A - H | Sod   |
| 3001        | Layer   | 30A - H | Topsoil with rubble                         |
| 3002        | Surface | 30A - D | Cobbled surface                             |
| 3003        | Feature | 30E     | Linear stone feature                        |
| 3004        | Layer   | 30F     | Metalled surface                            |
| 3005        | Layer   | 30F     | Dark loamy deposit                          |
| 3006        | Layer   | 30F     | Dark deposit with charcoal flecks           |
| 3007        | Layer   | 30G     | Yellowish brown natural layer above bedrock |
| 3008        | Bedrock | 30G     | Bedrock                                     |
| 3009        | Layer   | 30F - H | Topsoil without rubble                      |
| 3010        | Layer   | 30F     | Subsoil                                     |
| 3011        | Layer   | 30H     | Possible rubble collapse                    |
| 3012        | Feature | 30H     | Possible wall                               |
| 3013        | Layer   | 30D     | Brown loam deposit below topsoil            |
| 3014        | Deposit | 30H     | Subsoil                                     |
| 3015        | Bedrock | 30H     | Bedrock                                     |

| Context No. | Type    | Trench | Brief description                         |
|-------------|---------|--------|---|
| 3100        | Layer   | 31     | Sod                                       |
| 3101        | Layer   | 31     | Topsoil                                   |
| 3102        | Layer   | 31     | Stone and gravel layer below topsoil      |
| 3103        | Layer   | 31     | Thin loam layer below stone/gravel C.3102 |
| 3104        | Deposit | 31     | Natural                                   |

| Context No. | Type  | Trench | Brief description     |
|-------------|-------|--------|-----------------------|
| 3200        | Layer | 32     | Sod                   |
| 3201        | Layer | 32     | Topsoil               |
| 3202        | Layer | 32     | Raised stone platform |
| 3203        | Layer | 32     | Stony silt below 3202 |

## APPENDIX 2: HARRIS MATRICES

Individual Harris Matrices for each trench are listed below. The Phases have been colour coded as follows:

- Phase 1 represents the pre-17<sup>th</sup> century activity on the site.
- Phase 2 represents the 17<sup>th</sup> century occupation and incorporates the construction of the town which began in 1608, the renovations to the mainland castle buildings and the construction of the garden which has been dated to the 1630s (Breen 2012, 110).
- Phase 3 represents the abandonment of the site, dating from the end of the 17<sup>th</sup> century through to the present day
- Any unphased activity is in black

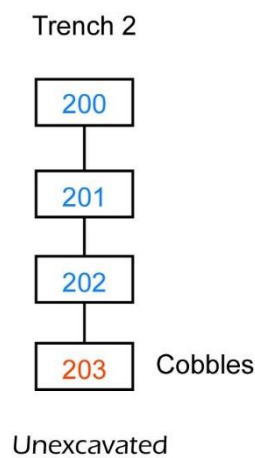
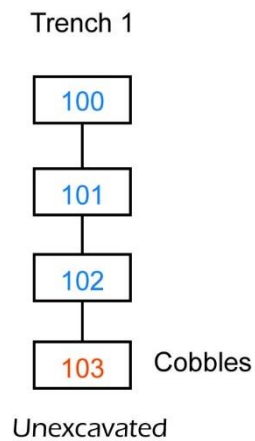

Trench 4

400

401

402

Cobbles

Unexcavated

Trench 5

501

Cobbles

502

Subsoil

Trench 29

2900

2901

2902

2903

Bedrock



Trench 26a

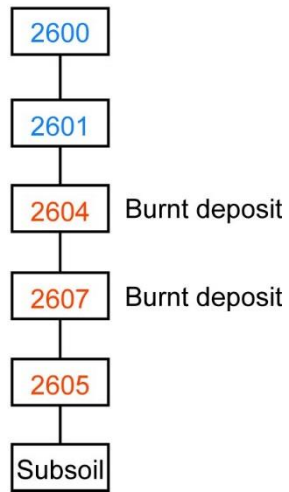

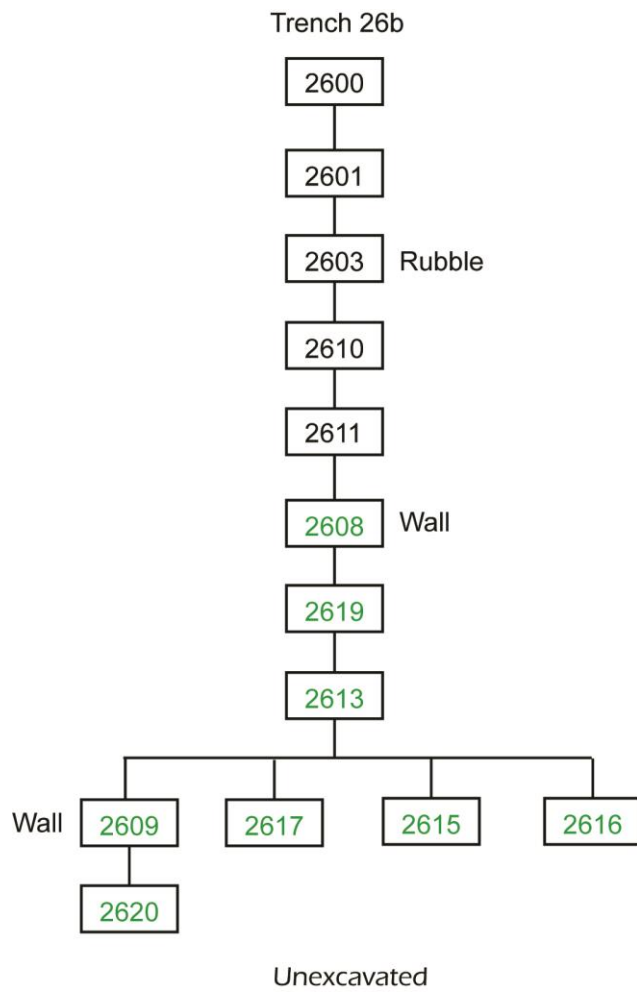

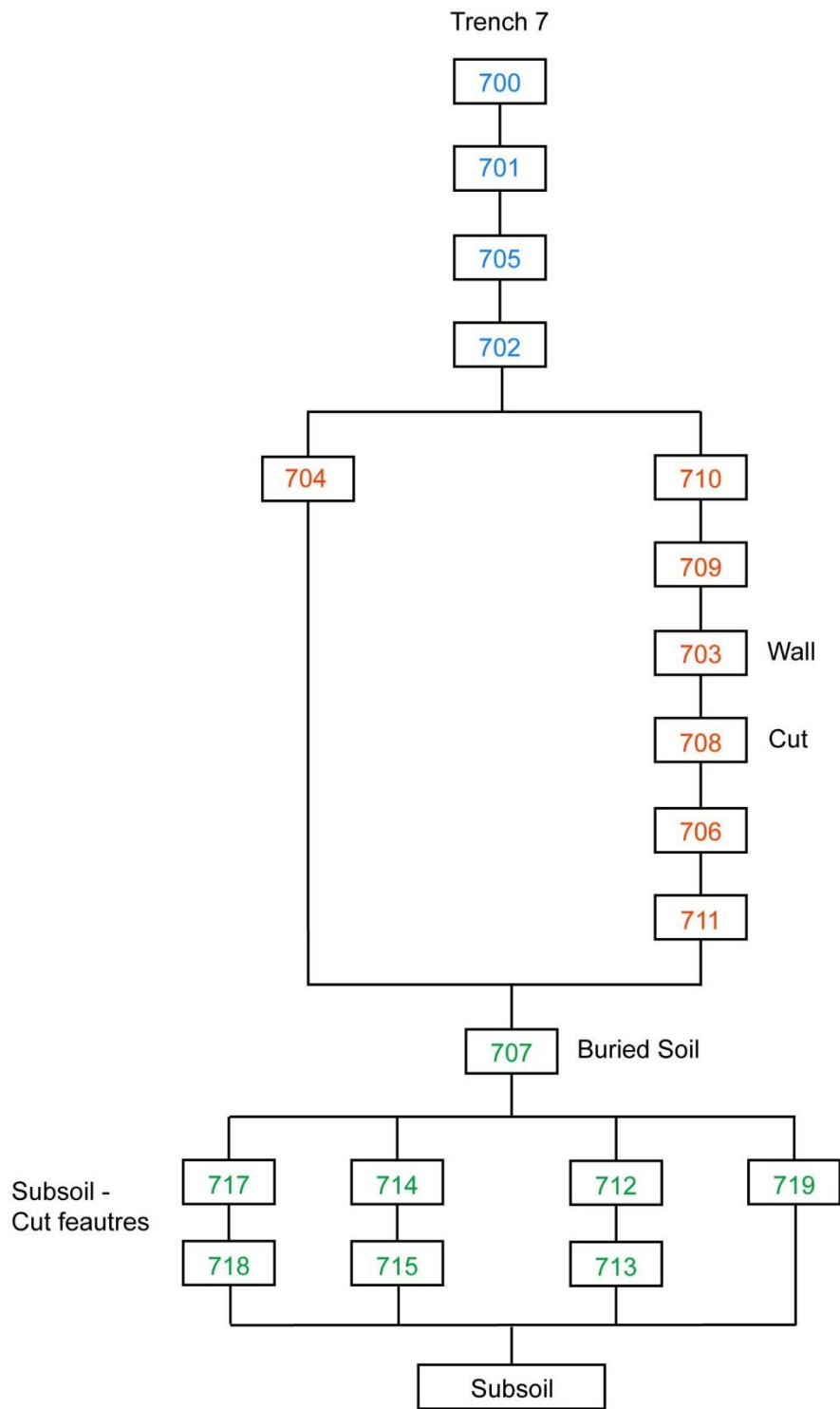

Trench 8

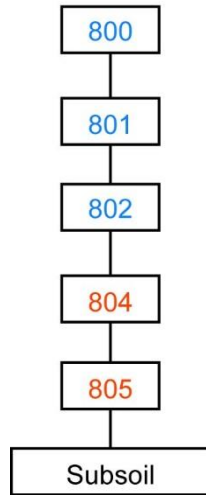

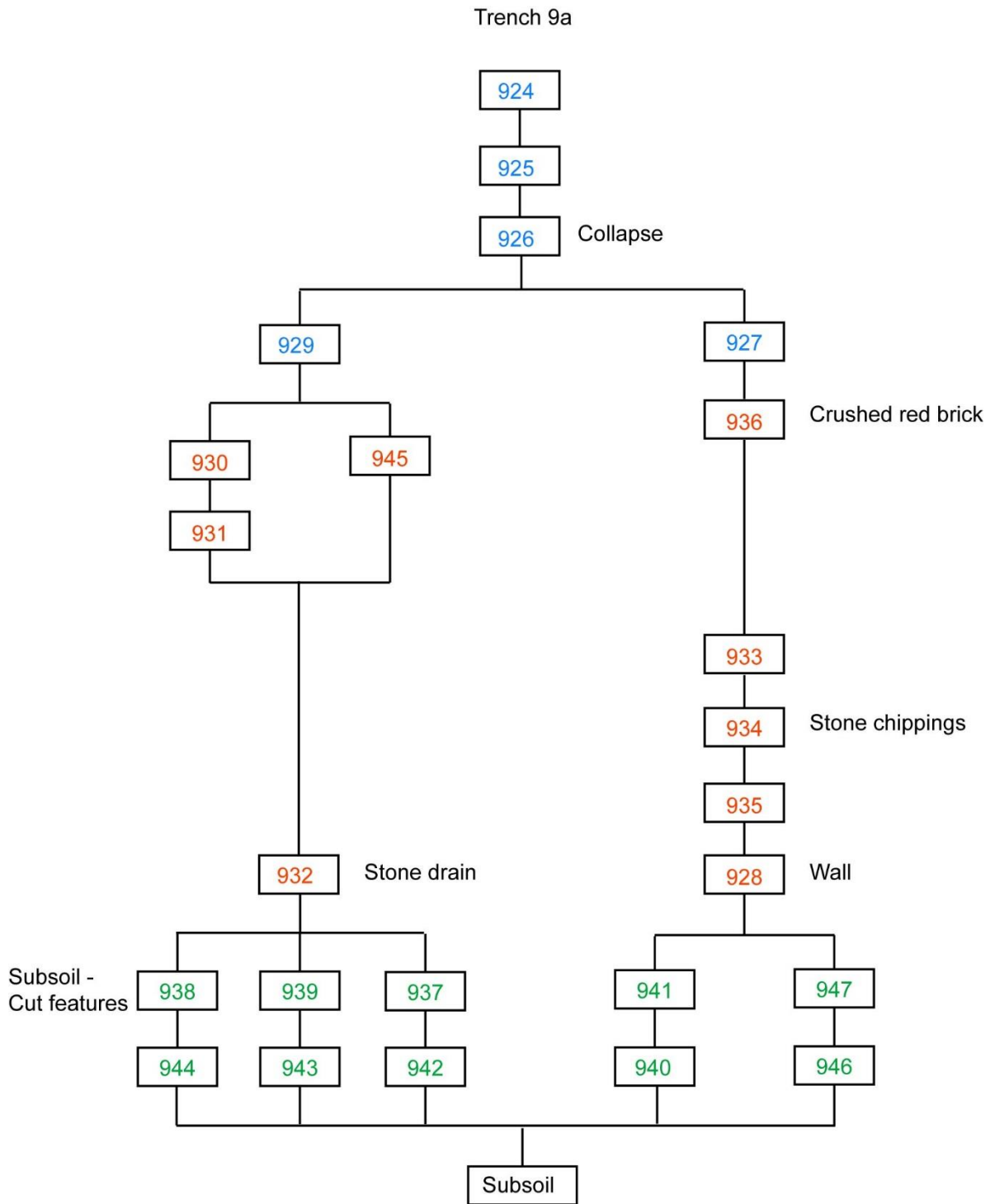

Trench 9b

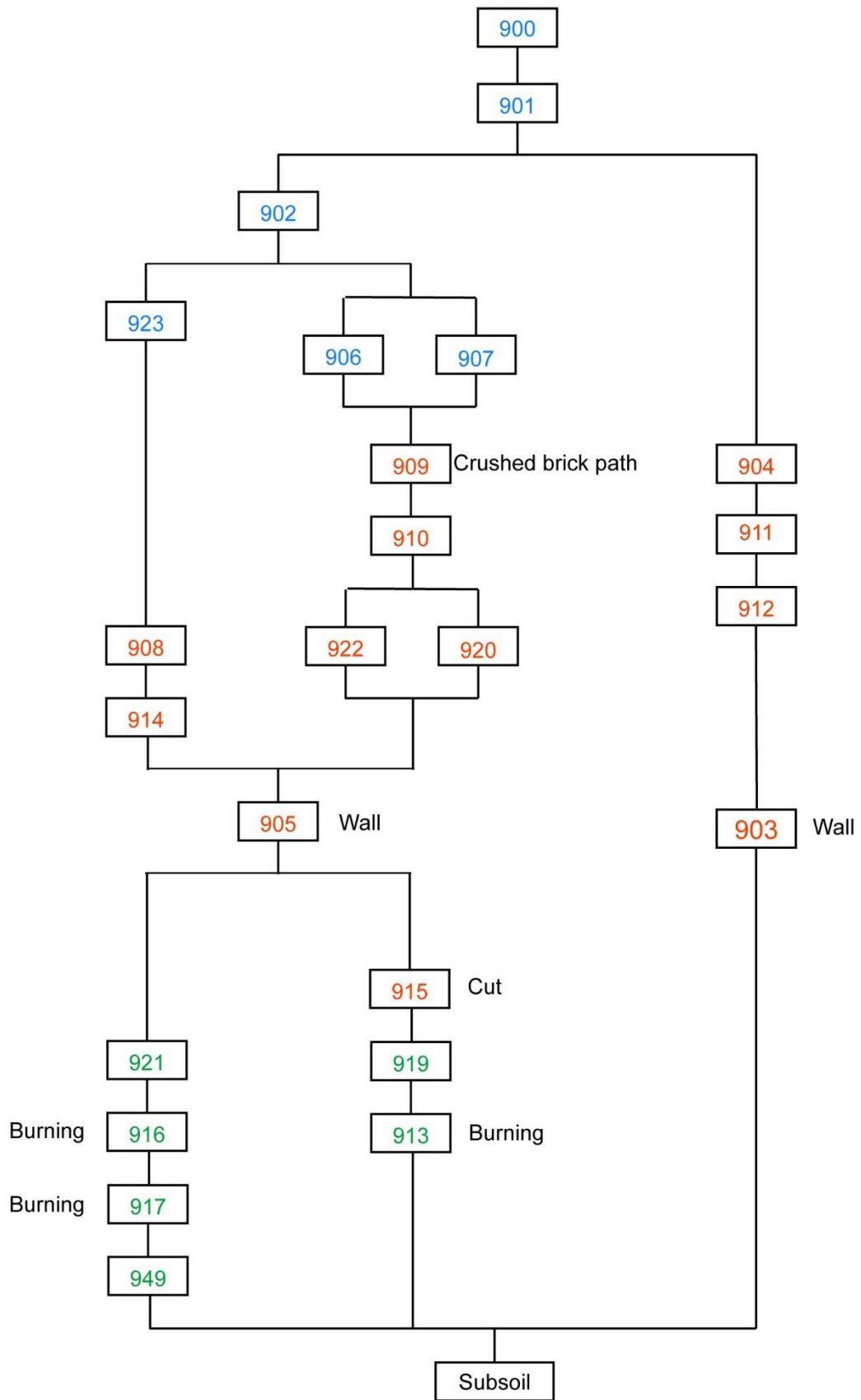

Trench 10

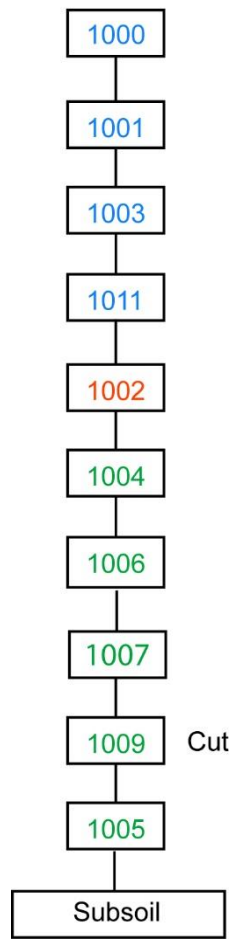

Trench 11

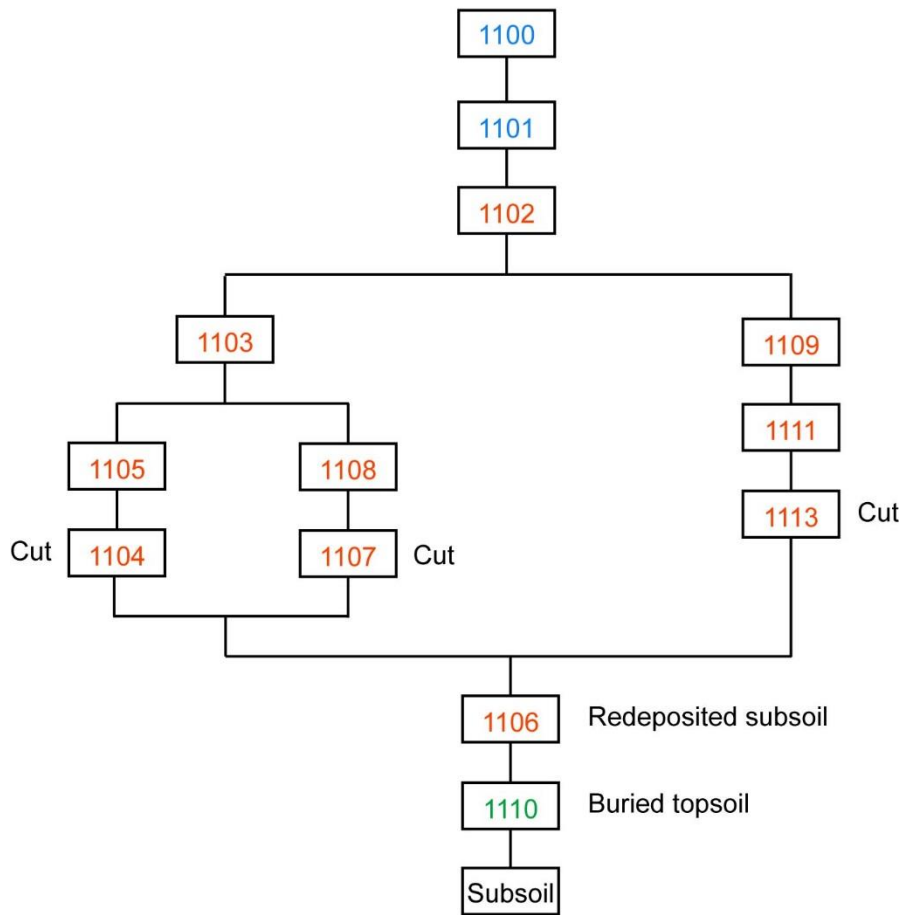



Trench 12

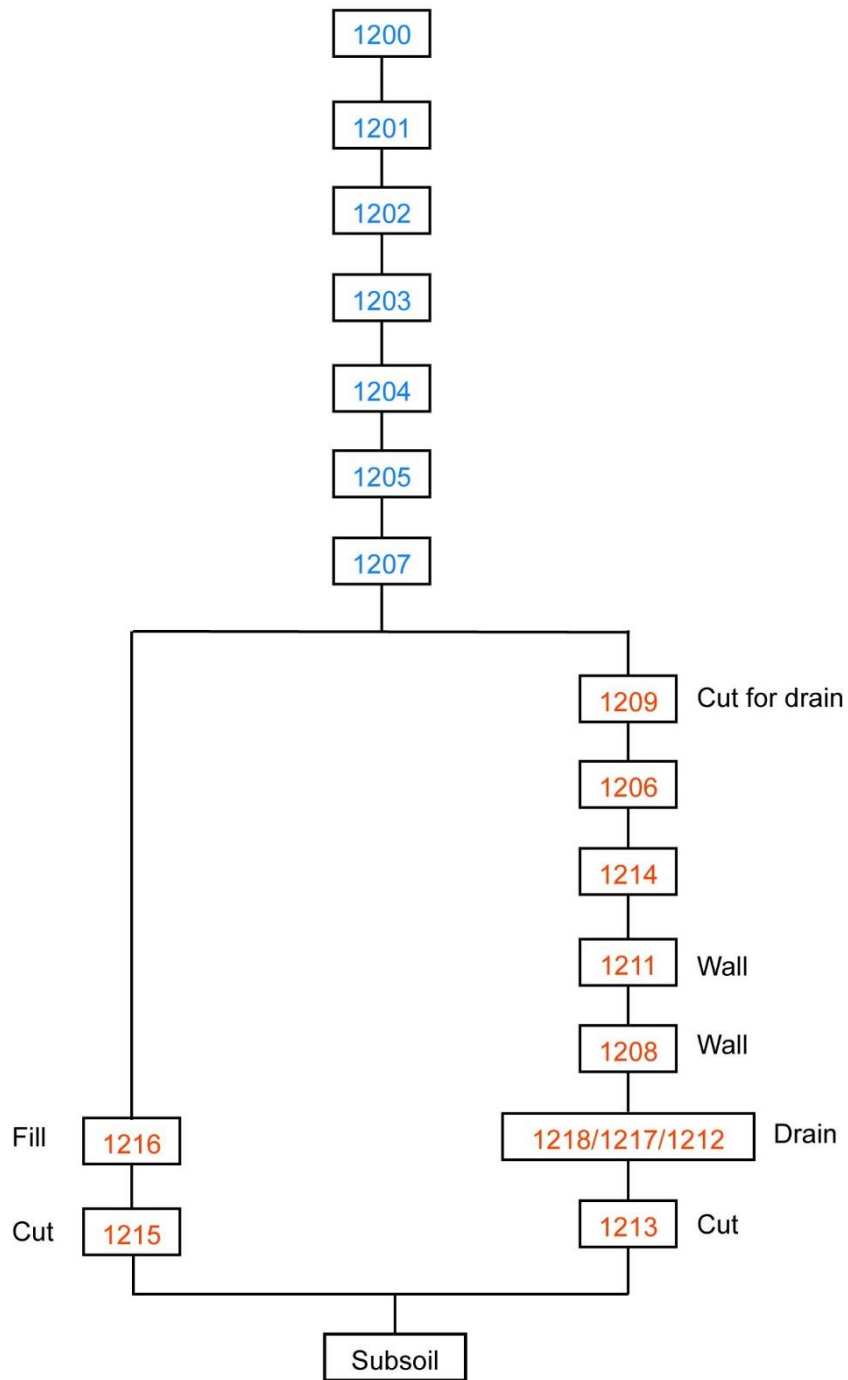

Trench 13a

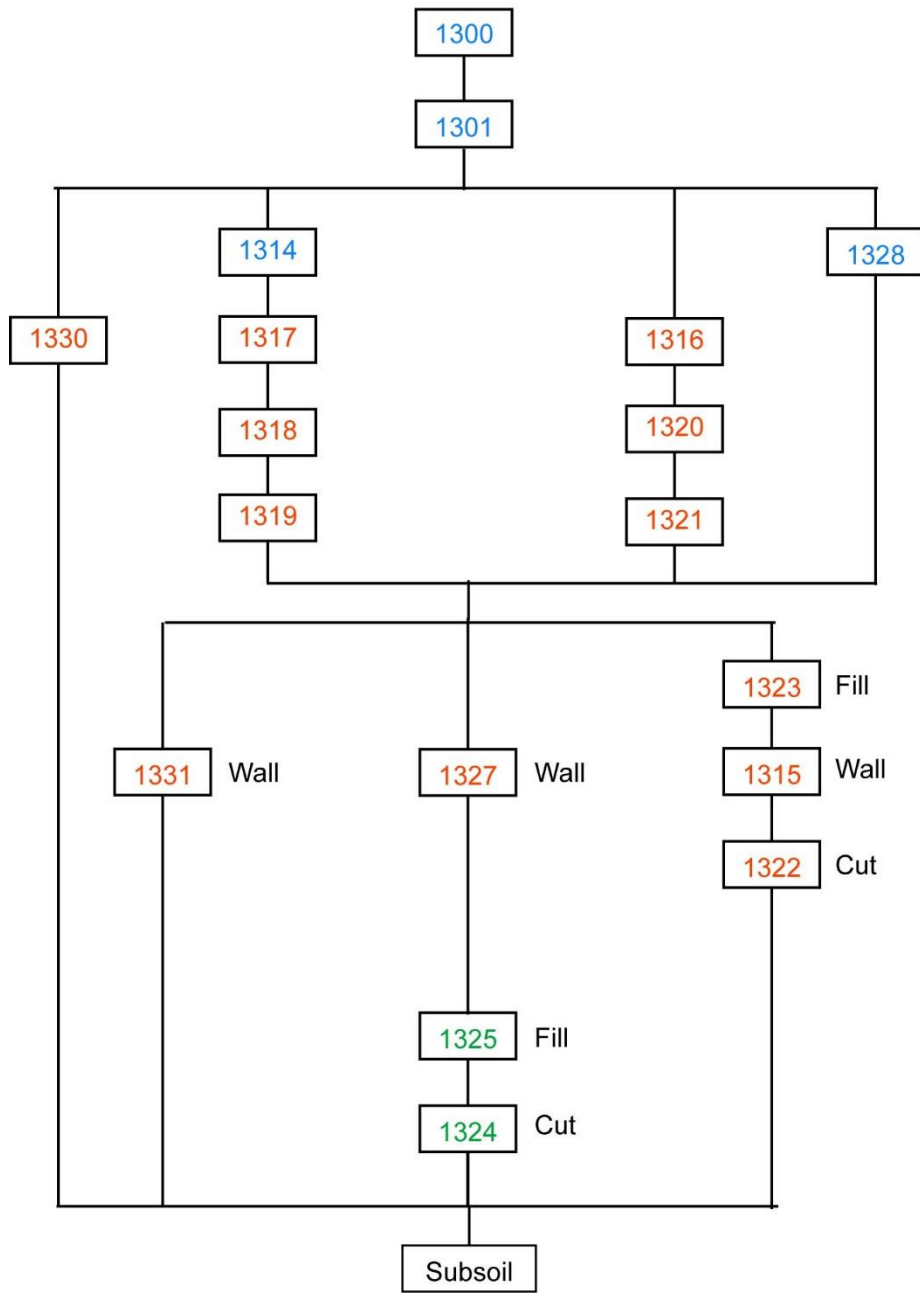

Trench 13b

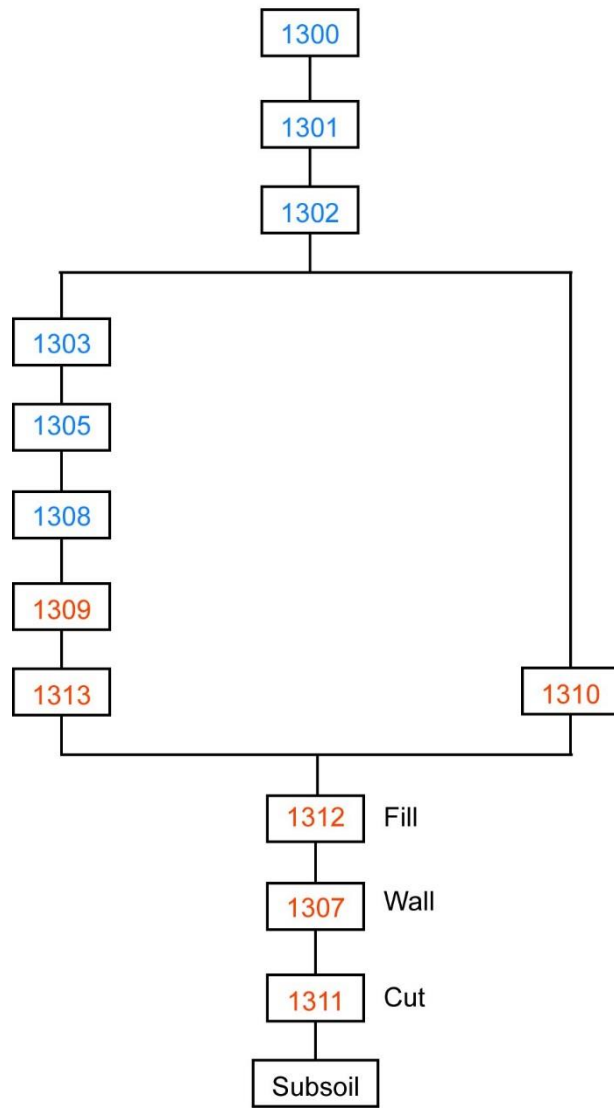

Trench 14

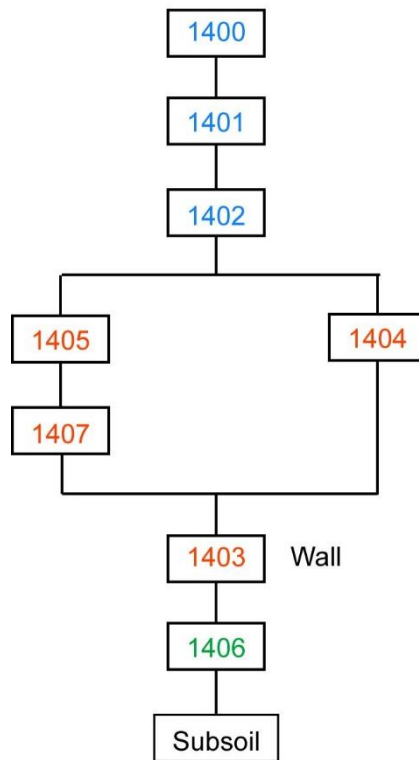

Trench 15a

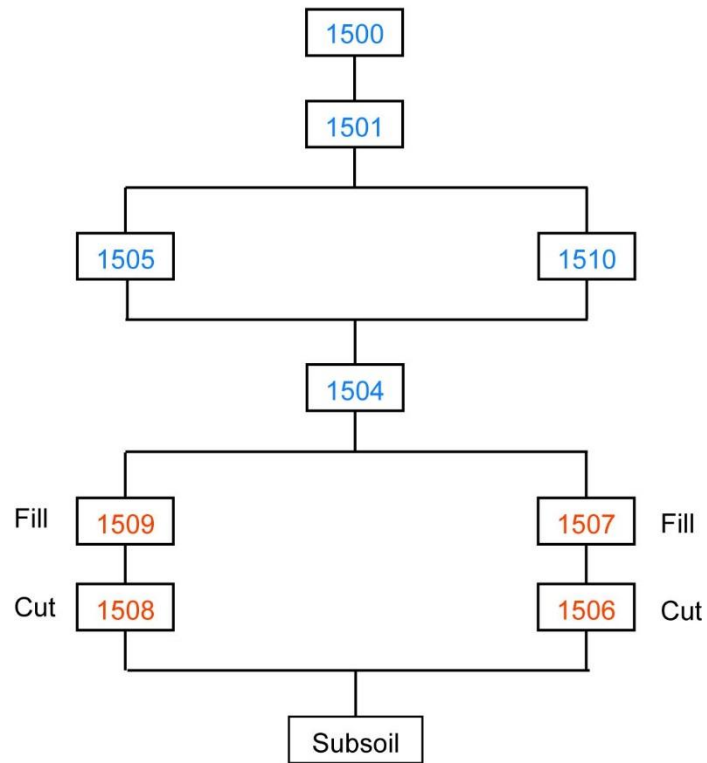

Trench 15b

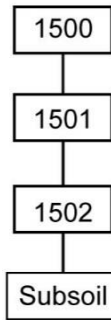

Trench 16

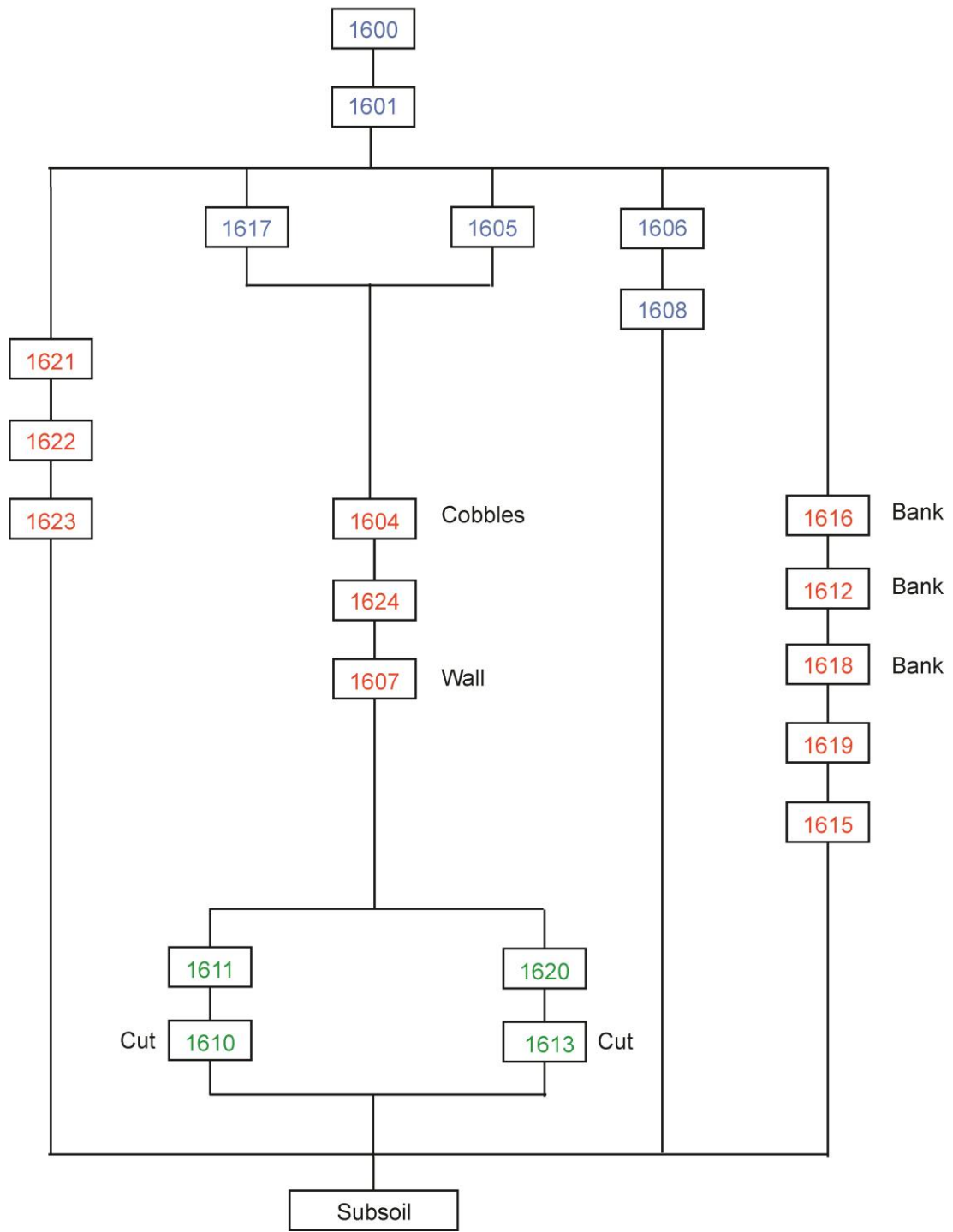

Trench 17

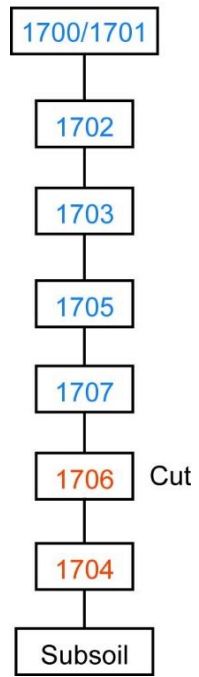

Trench 20

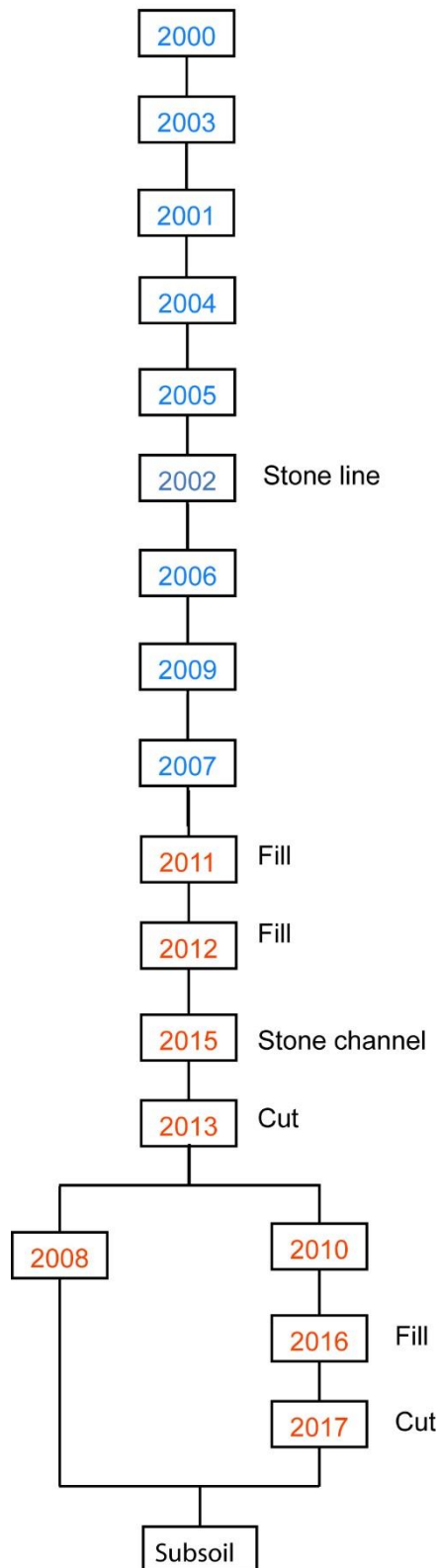



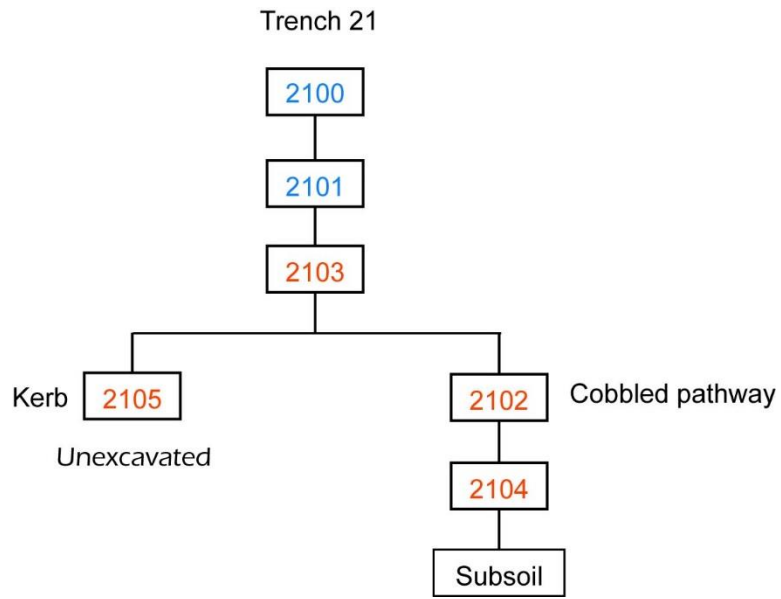

Trench 22a

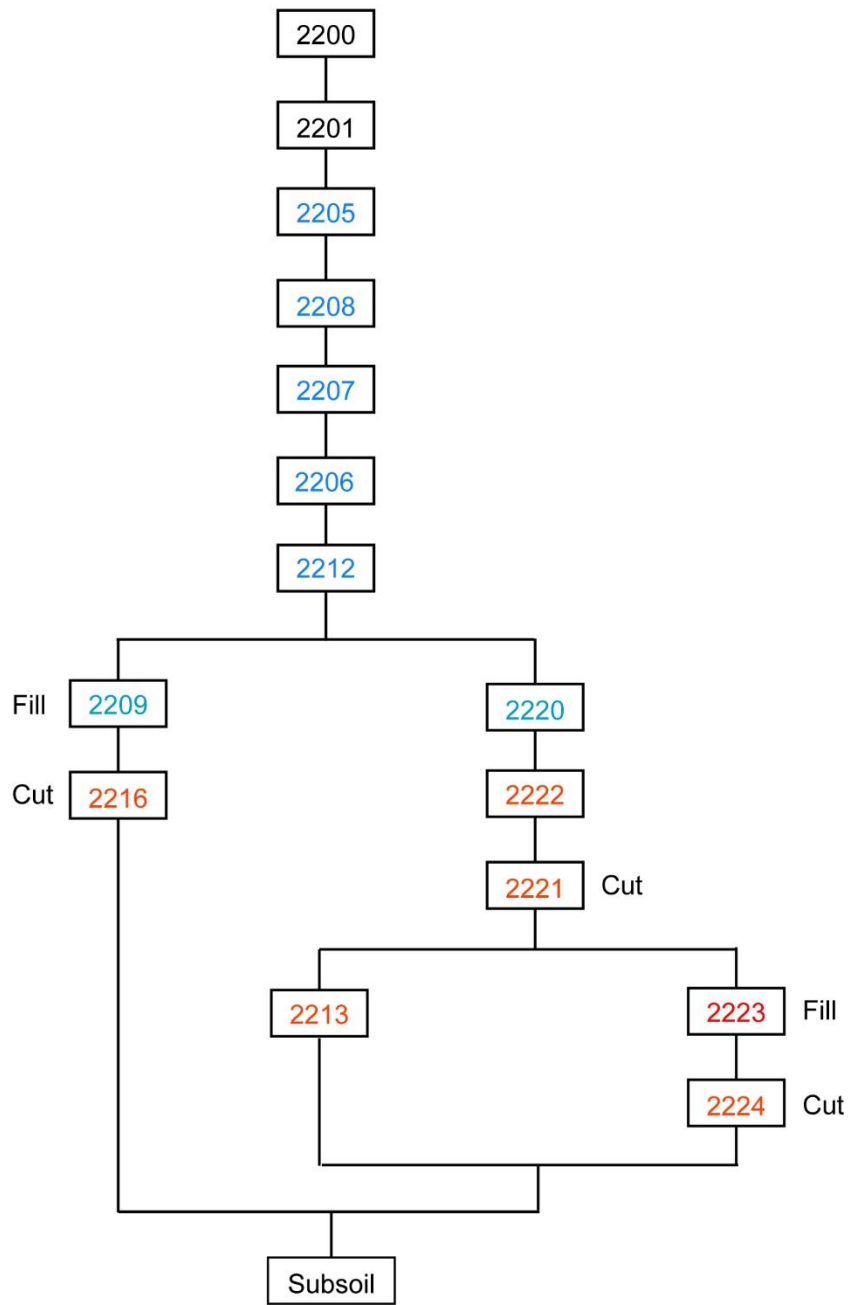

Trench 22b

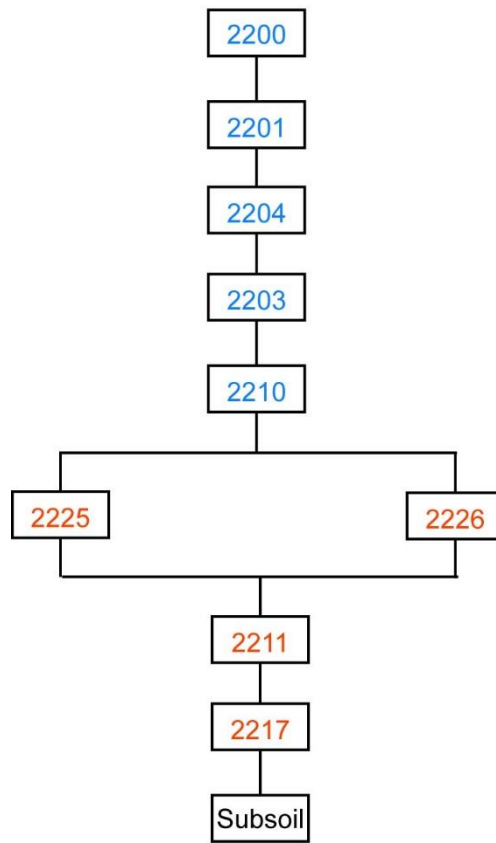

Trench 22c

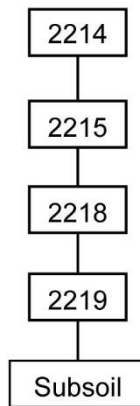

Trench 23a

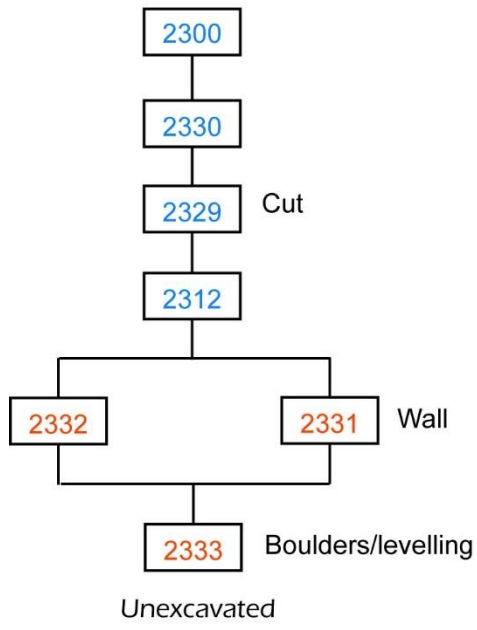

Trench 23b

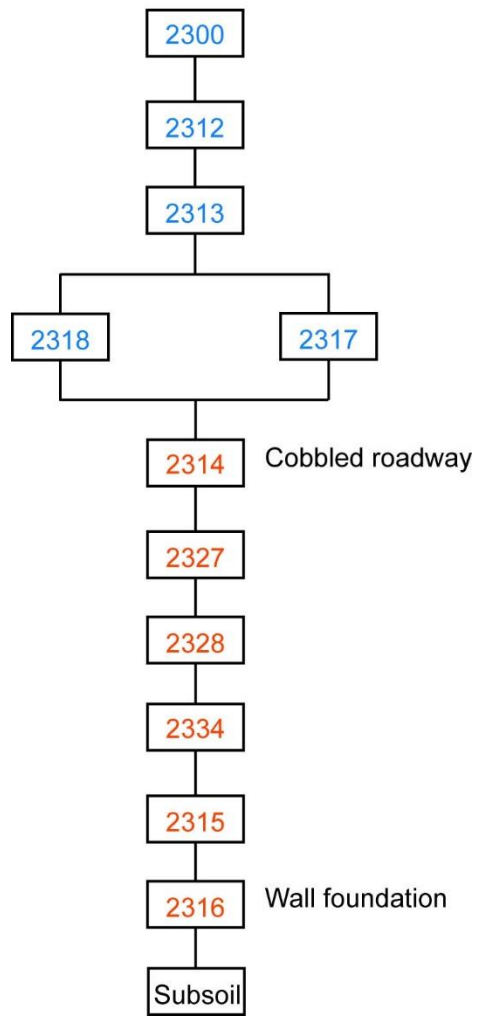

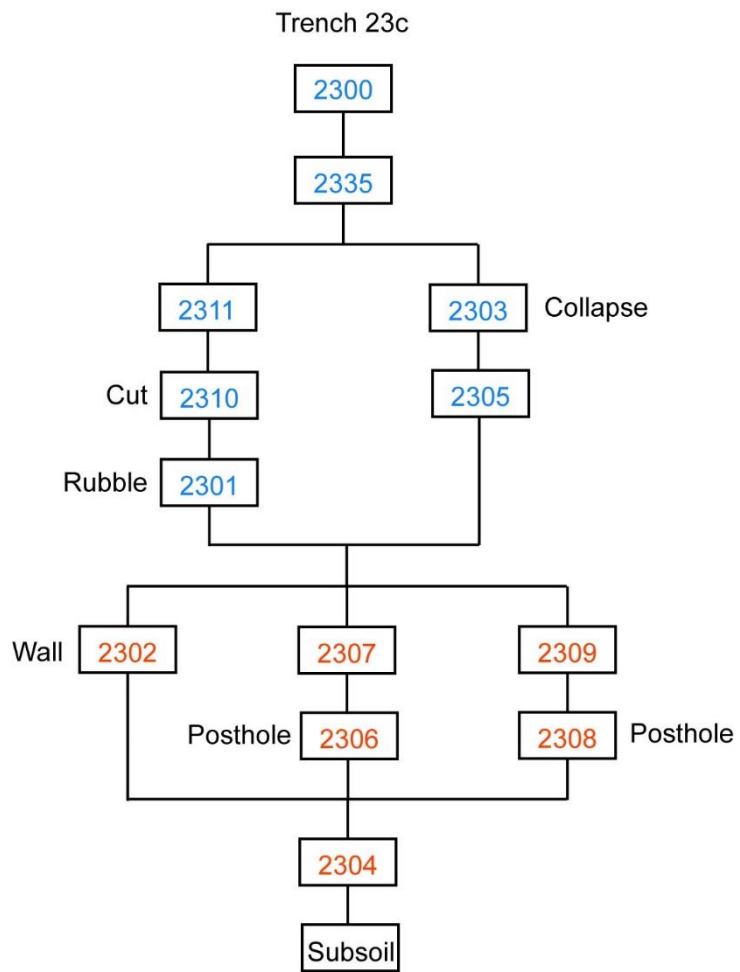

Trench 23d

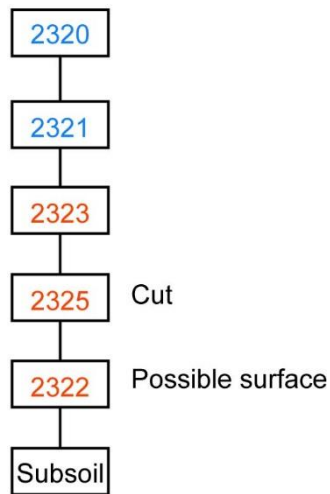

Trench 25a

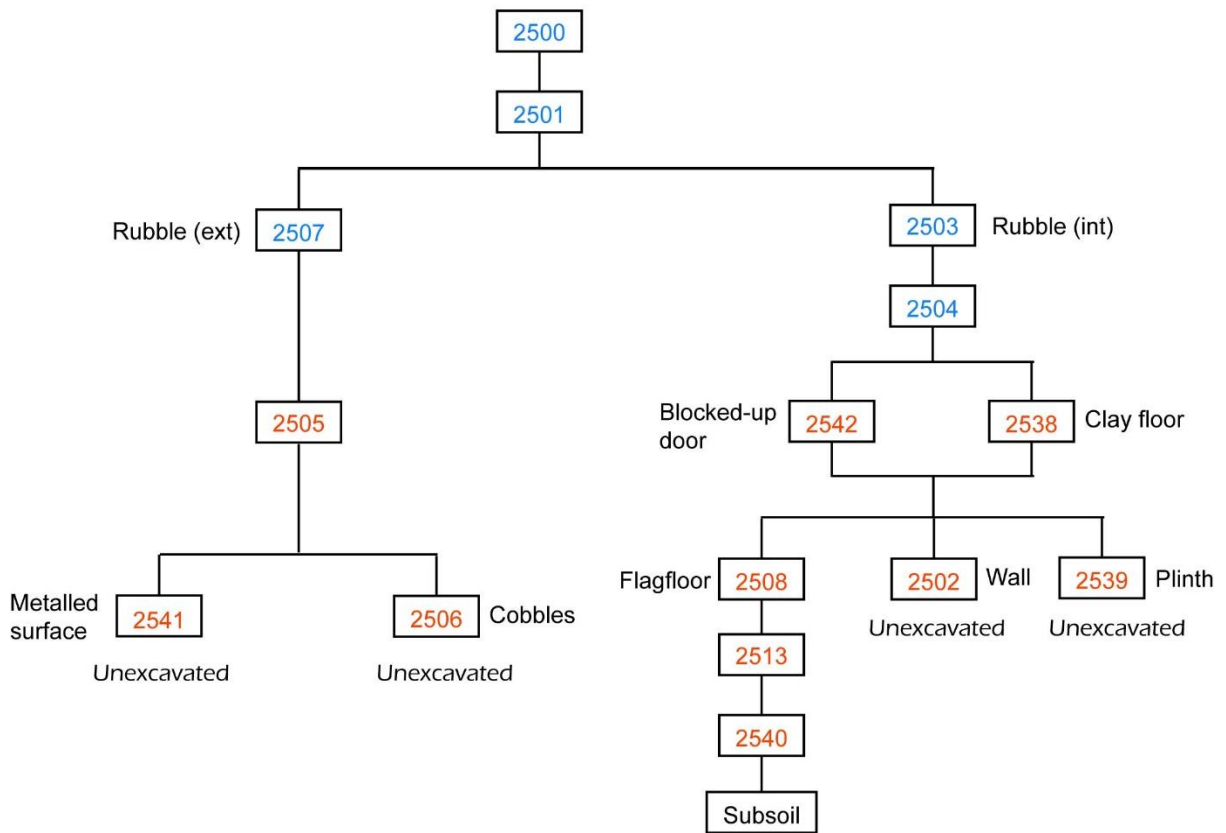

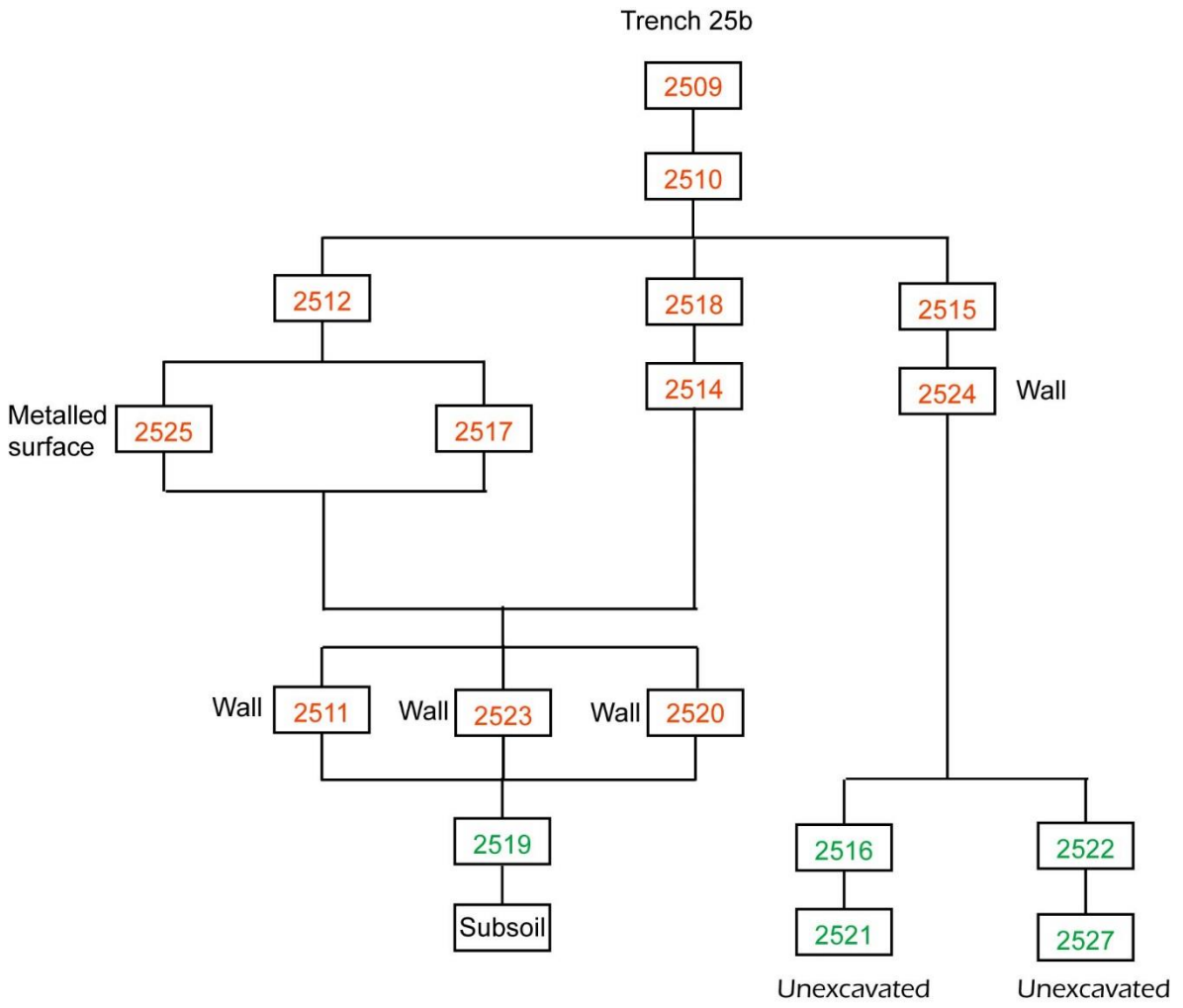



Trench 25c

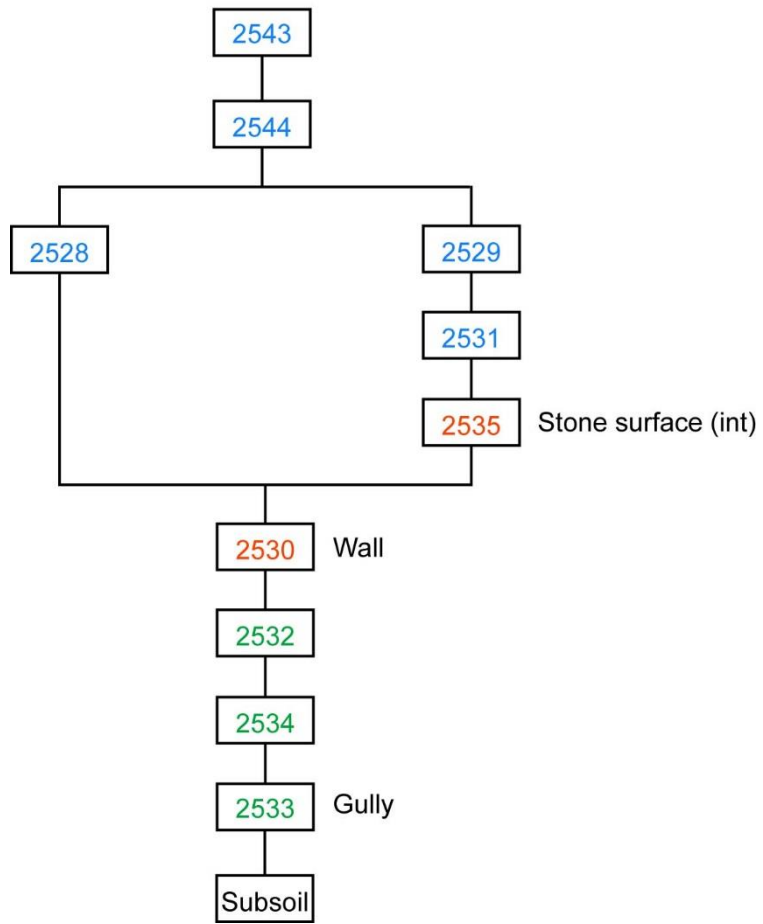

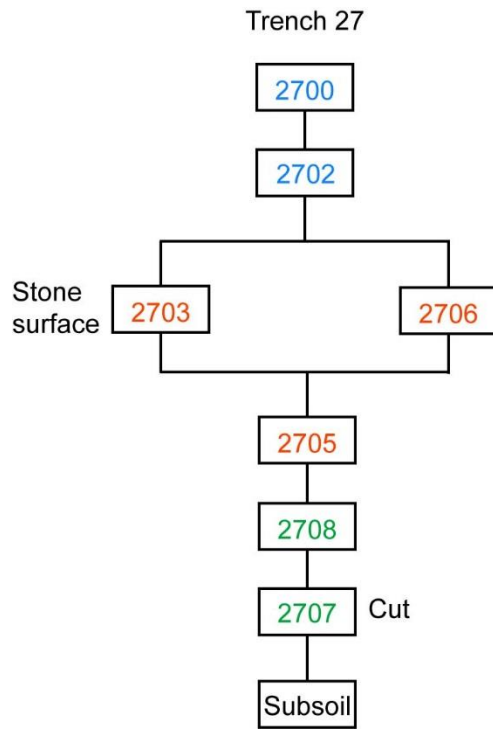

Trench 28

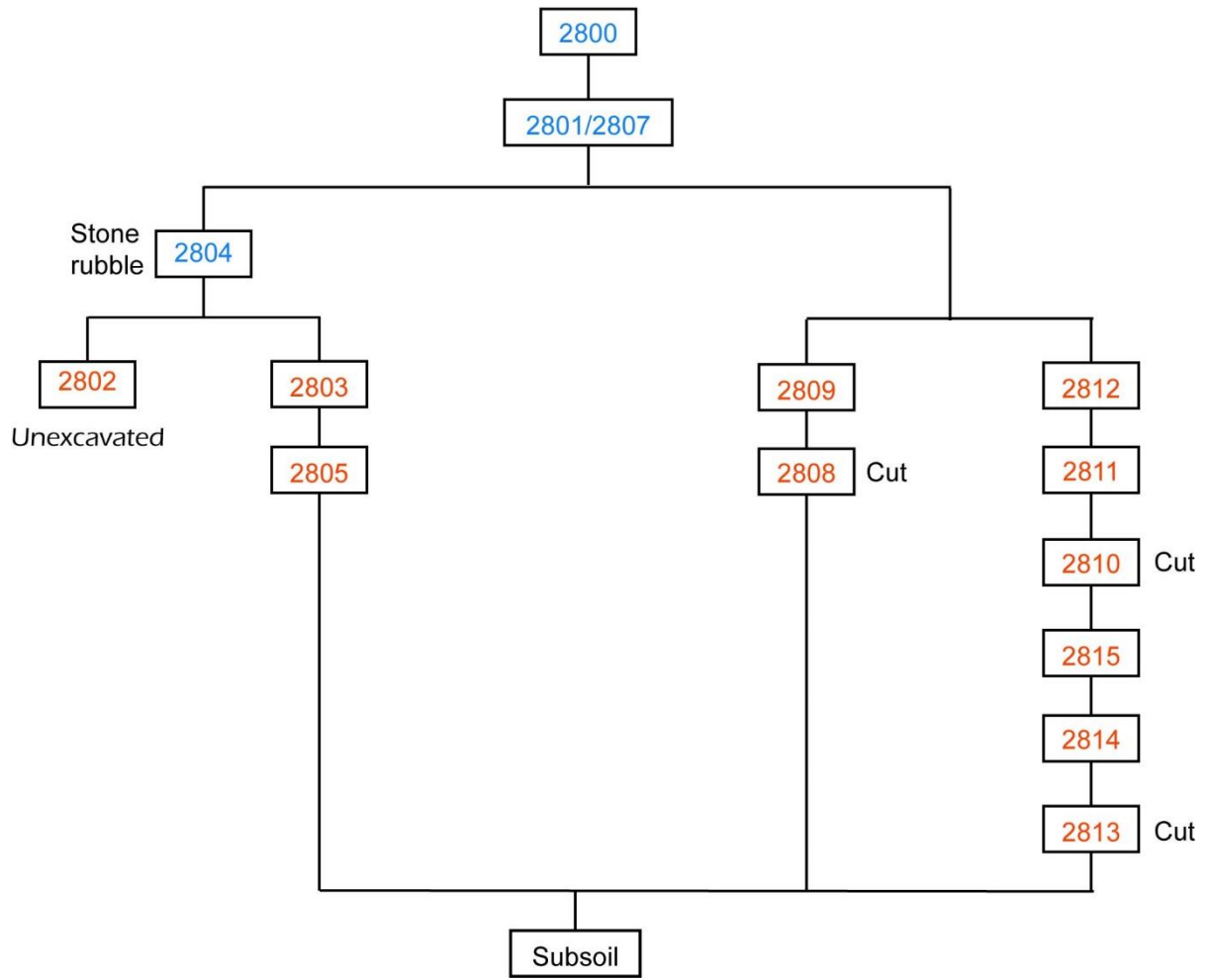

Trench 30a

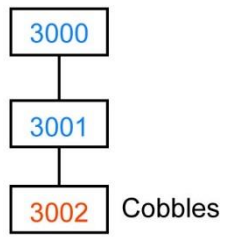

Unexcavated

Trench 30b

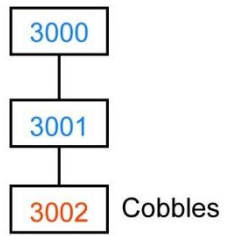

Unexcavated

Trench 30c

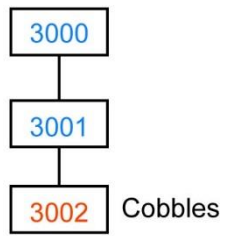

Unexcavated

Trench 30d



Unexcavated

Trench 30e



Trench 30f

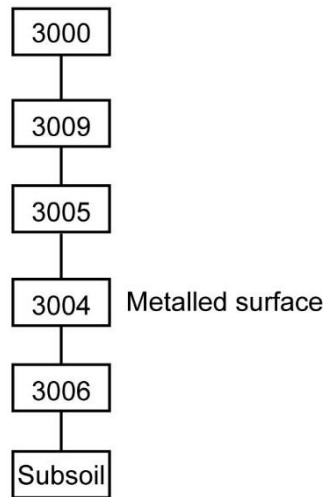

Trench 30g

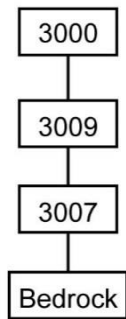

Trench 30h

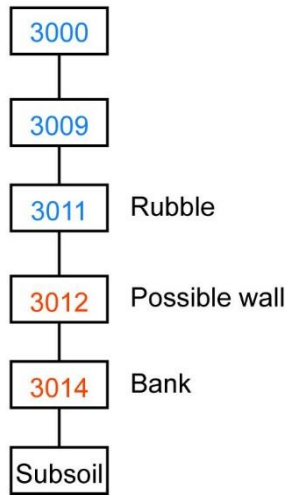

Trench 31

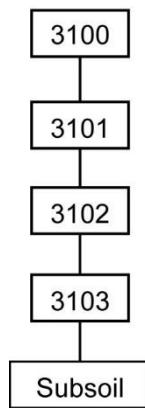

Trench 32

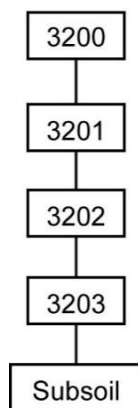

### APPENDIX 3 DRAWING REGISTER

| Drawing No. | Type      | Scale | Area | Trench | Description   |
|-------------|-----------|-------|------|--------|---|
| 1           | Plan      | 01:10 | C    | 4      | Post-ex plan of cobbled surface (402)   |
| 2           | Section   | 01:10 | C    | 4      | West-facing section of Trench 4, showing 400, 401, 402                                  |
| 3           | Plan      | 01:10 | C    | 1      | Post-ex plan of cobbles (103)   |
| 4           | Section   | 01:10 | C    | 1      | East-facing section of Trench 1, showing 100,101,102,103                                |
| 5           | Plan      | 01:10 | C    | 2      | Post-ex plan of cobbled surface (203)   |
| 6           | Section   | 01:10 | C    | 2      | East facing section of Trench 2, showing 200 ,201, 202, 203                             |
| 7           | Section   | 01:10 | D    | 5      | South-facing section of trench 5, showing 501, 502, 503                                 |
| 8           | Plan      | 01:20 | G    | 16     | Pre-ex plan of cobbles and wall/bank collapse   |
| 9           | Plan      | 01:20 | G    | 8      | Plan of Trench 8 after the removal of topsoil, showing 802, 803                         |
| 10          | Plan      | 01:20 | G    | 13B    | Plan of Trench 13B after removal of topsoil and excavation of sondage in east of trench |
| 11          | Plan      | 01:20 | G    | 16     | Plan following removal of rubble layers   |
| 12          | Plan      | 01:20 | G    | 7      | Plan of Trench 8 after removal of topsoil, showing 702, 703, 704, 705                   |
| 13          | Plan      | 01:20 | G    | 14     | Plan showing 1402   |
| 14          | Plan      | 01:20 | G    | 14     | Plan after removal of 1402, showing 1403, 1404, 1405                                    |
| 15          | Plan      | 01:20 | G    | 13B    | Plan after removal of 1302,1303   |
| 16          | Section   | 01:10 | G    | 8      | East-facing section of Trench 8   |
| 17          | Section   | 01:10 | G    | 8      | South-facing section  |
| 18          | Section   | 01:10 | G    | 13B    | West-facing section   |
| 19          | Elevation | 01:10 | G    | 13B    | North-facing elevation of wall  |
| 20          | Plan      | 01:20 | G    | 13A    | Plan of Trench 13A following removal of sod C.1300                                      |
| 21          | Plan      | 01:20 | G    | 14     | Post-ex plan of Trench 14, showing 1403(wall), 1408                                     |
| 22          | Plan      | 01:20 | G    | 7      | Showing Trench 7 after removal of rubble, and showing 703, 704, 707                     |
| 23          | Section   | 01:10 | G    | 14     | West-facing section of Trench 14  |
| 24          | Section   | 01:10 | G    | 14     | South-facing section of Trench 14   |
| 25          | Elevation | 01:10 | G    | 16     | North-facing elevation of wall 1607   |
| 26          | Elevation | 01:10 | G    | 16     | South-facing elevation of wall 1607   |



|    |           |       |   |     |  |
|----|-----------|-------|---|-----|--|
| 27 | Section   | 01:10 | G | 13A | South-facing section   |
| 28 | Section   | 01:10 | G | 13A | East-facing section  |
| 29 | Section   | 01:10 | G | 13A | North-facing section   |
| 30 | Section   | 01:10 | G | 16  | East-facing section  |
| 31 | Elevation | 01:10 | G | 13A | East-facing elevation of wall  |
| 32 | Elevation | 01:10 | G | 13A | West-facing elevation of wall  |
| 33 | Section   | 01:10 | G | 13A | West-facing section  |
| 34 | Plan      | 01:20 | G | 13A | Post-ex plan of Trench 13A   |
| 35 | Plan      | 01:20 | G | 9B  | Plan of Trench 9B, showing 904, 906, 903, 902, 907                   |
| 36 | Plan      | 01:20 | G | 9B  | Plan following removal of rubble 906 and 907                         |
| 37 | Plan      | 01:20 | T | 20  | Plan of deposits 2001, 2002, 2003                                    |
| 38 | Plan      | 01:20 | G | 15A | Plan of deposits 1504, 1505, 1506                                    |
| 39 | Plan      | 01:20 | G | 13A | Plan of Trench 13A with N and S extensions prior to excavation       |
| 40 | Elevation | 01:10 | G | 13A | Elevation of east-face of wall with south extension                  |
| 41 | Elevation | 01:10 | G | 13A | Elevation of west-face of wall with north extension                  |
| 42 | Section   | 01:10 | G | 13A | Section of east-facing section in north extension                    |
| 43 | Elevation | 01:10 | G | 13A | Elevation of north-face of wall exposed in north extension           |
| 44 | Section   | 01:10 | G | 7   | West facing section of Trench 7, southern 3rd. Parts 1,2&3. 700 -715 |
| 45 | Plan      | 01:20 | G | 13A | Post-ex plan of Trench 13A with north extension                      |
| 46 | Plan      | 01:20 | G | 15B | Plan of Trench 15B after removal of 1502, showing 1503               |
| 47 | Plan      | 01:20 | G | 15A | Post-ex plan of Trench 15A   |
| 48 | Plan      | 01:20 | G | 9B  | Plan of Trench 9B after removal of rubble, 906 and 907               |
| 49 | Plan      | 01:20 | G | 7   | Post-ex plan of Trench 7   |
| 50 | Section   | 01:10 | G | 15A | North-facing section of Trench 15A                                   |
| 51 | Plan      | 01:20 | G | 13B | Post-ex plan of Trench 13B   |
| 52 | Plan      | 01:20 | T | 20  | Plan of deposits 2002, 2006, 2008, 2009, 2010                        |
| 53 | Section   | 01:10 | G | 15B | North-facing section, post-ex  |
| 54 | Section   | 01:10 | G | 15B | East-facing section, post-ex   |
| 55 | Plan      | 01:20 | T | 23C | Pre-ex plan of Trench 23C following removal of sod                   |
| 56 | Plan      | 01:20 | T | 20  | Plan of deposits 2002, 2006, 2008, 2010, 2011                        |

|    |           |       |   |     |   |
|----|-----------|-------|---|-----|---|
| 57 | Plan      | 01:20 | T | 20  | Plan of deposits 2008, 2010, 2011   |
| 58 | Plan      | 01:20 | T | 20  | Plan following excavation of cut 2013                                     |
| 59 | Plan      | 01:20 | G | 9B  | Plan of Trench 9B, following removal of 911-908                           |
| 60 | Elevation | 01:10 | G | 7   | North-facing elevation of wall 703  |
| 61 | Elevation | 01:10 | G | 7   | South-facing elevation of wall 703  |
| 62 | Plan      | 01:20 | T | 23C | Post-ex plan of Trench 23C  |
| 63 | Elevation | 01:10 | T | 23C | North-facing section  |
| 64 | Plan      | 01:20 | T | 20  | Post-ex plan of Trench 20   |
| 65 | Section   | 01:10 | T | 20  | North-facing section  |
| 66 | Section   | 01:10 | T | 23C | West-facing section   |
| 67 | Elevation | 01:10 | T | 23C | East-face of wall   |
| 68 | Elevation | 01:10 | T | 23C | West-face of wall   |
| 69 | Plan      | 01:20 | G | 9A  | Plan of Trench 9A after removal of topsoil                                |
| 70 | Plan      | 01:20 | G | 12  | Plan of Trench 12, after removal of 1202                                  |
| 71 | Plan      | 01:20 | T | 23B | Mid-ex plan of Trench 23b before removal of collapse, 2315                |
| 72 | Plan      | 01:20 | T | 20  | Post-ex plan of Trench 20   |
| 73 | Section   | 01:10 | T | 23C | South-facing section of Trench 23C  |
| 74 | Plan      | 01:20 | G | 9A  | Plan of Trench 9A , after removal of stone collapse, showing path         |
| 75 | Section   | 01:20 | G | 9B  | East-facing section   |
| 76 | Elevation | 01:10 | G | 9B  | South-facing elevation of the northern wall                               |
| 77 | Elevation | 01:10 | G | 9B  | North-facing elevation of the northern wall                               |
| 78 | Elevation | 01:10 | G | 9B  | North-facing elevation of southern wall                                   |
| 79 | Elevation | 01:10 | G | 9B  | South-facing elevation of southern wall                                   |
| 80 | Plan      | 01:20 | G | 9B  | Post-ex plan following removal of C.902                                   |
| 81 | Plan      | 01:20 | G | 12  | Plan following removal of 1203, 1204, showing 1205, 1206, 1207, 1208      |
| 82 | Section   | 01:10 | G | 9B  | South-facing section at north end of Trench 9B                            |
| 83 | Section   | 01:10 | G | 9B  | North-facing section at south end of Trench 9B                            |
| 84 | Plan      | 01:20 | G | 9B  | post-ex plan of Trench 9B   |
| 85 | Plan      | 01:20 | G | 10  | Mid-ex plan of Trench 10, showing 1002 to the north and 1003 to the south |
| 86 | Plan      | 01:20 | T | 23D | Mid-ex plan of Trench 23D, showing path and burnt material                |

|     |           |       |   |       |  |
|-----|-----------|-------|---|-------|--|
| 87  | Plan      | 01:20 | G | 17    | Plan following removal of 1703, showing surface of 1704, 1705            |
| 88  | Section   | 01:10 | T | 23D   | West-facing section  |
| 89  | Section   | 01:10 | T | 23D   | East-facing section  |
| 90  | Section   | 01:10 | T | 23D   | North-facing section   |
| 91  | Plan      | 01:20 | T | 23D   | Post-ex plan of Trench 23D   |
| 92  | Plan      | 01:20 | G | 9A    | Plan following removal of 929  |
| 93  | Section   | 01:10 | T | 23A&B | North-facing section   |
| 94  | Plan      | 01:20 | T | 23B   | Post-ex plan of Trench 23B   |
| 95  | Plan      | 01:20 | T | 23A   | Post-ex plan of Trench 23A   |
| 96  | Plan      | 01:20 | G | 9A    | Post-ex plan of trench 9A  |
| 97  | Section   | 01:10 | T | 23A   | East-facing section  |
| 98  | Section   | 01:10 | T | 23A&B | West-facing section of Trench 23A and east-facing section of Trench 23B  |
| 99  | Elevation | 01:10 | G | 9A    | East-facing elevation of wall in eastern part of Trench 9A               |
| 100 | Plan      | 01:20 | G | 10    | Mid-ex plan of Trench 10, showing cut feature 1004                       |
| 101 | Section   | 01:10 | G | 9A    | South-facing section   |
| 102 | Elevation | 01:10 | G | 9A    | East-facing elevation of stone feature 932                               |
| 103 | Elevation | 01:10 | G | 9A    | West-facing elevation of stone feature 932                               |
| 104 | Section   | 01:10 | G | 9A    | East-facing section, post-ex   |
| 105 | Section   | 01:10 | G | 9A    | West-facing section, post-ex   |
| 106 | Section   | 01:10 | G | 9A    | North-facing section of stone/drain feature (932)                        |
| 107 | Section   | 01:10 | G | 9A    | South-facing section of 932  |
| 108 | Elevation | 01:10 | G | 9A    | West-facing elevation of stone wall 928                                  |
| 109 | Elevation | 01:10 | G | 17    | West-facing elevation of stone wall and footings                         |
| 110 | Section   | 01:10 | G | 17    | South-facing section   |
| 111 | Plan      | 01:20 | T | 25A   | Plan of Trench 25A, after removal of sod and topsoil, showing 2502, 2503 |
| 112 | Plan      | 01:20 | T | 27    | Plan of Trench 27, exposing stone surface                                |
| 113 | Plan      | 01:20 | G | 10    | Post-ex plan of trench 10, showing 1009(cut), 1002, 1008                 |
| 114 | Plan      | 01:20 | G | 17    | Post-ex plan of Trench 17  |
| 115 | Section   | 01:10 | G | 17    | North-facing section   |
| 116 | Section   | 01:20 | G | 10    | West-facing section  |

|     |           |       |   |     |  |
|-----|-----------|-------|---|-----|--|
| 117 | Section   | 01:20 | G | 10  | South-facing section   |
| 118 | Plan      | 01:20 | T | 25B | Plan of Trench 25B, after removal of topsoil   |
| 119 | Plan      | 01:20 | G | 12  | Post-ex plan of Trench 12  |
| 120 | Section   | 01:10 | T | 27  | East-facing section  |
| 121 | Section   | 01:10 | T | 27  | West-facing section  |
| 122 | Plan      | 01:20 | T | 27  | Mid-ex plan of Trench 27   |
| 123 | Plan      | 01:20 | T | 27  | Post-ex plan of Trench 27  |
| 124 | Section   | 01:10 | G | 12  | East-facing section, post-ex   |
| 125 | Plan      | 01:20 | T | 28  | Post-ex plan of Trench 28  |
| 126 | Plan      | 01:20 | T | 25A | Plan of Trench 25A, after removal of 2507, 2504, showing cobbled road and internal surface |
| 127 | Plan      | 01:20 | T | 25B | Plan of Trench 25B, after removal of some of 2511  |
| 128 | Section   | 01:10 | G | 12  | Post-ex elevation of north-facing section, showing C.1208                                  |
| 129 | Plan      | 01:20 | E | 26A | Mid-ex plan of 2601 (topsoil) and 2602 (stones)  |
| 130 | Section   | 01:10 | G | 12  | West-facing section, post-ex   |
| 131 | Plan      | 01:20 | T | 25B | Plan of Trench 25B, following removal of 2512,2514, 2516, 2517 and some of 2515            |
| 132 | Elevation | 01:10 | T | 25B | Elevation of wall 2520 running east-west   |
| 133 | Plan      | 01:20 | T | 25B | Post-ex plan of Trench 25B   |
| 134 | Plan      | 01:20 | E | 26B | Surface of 2603  |
| 135 | Elevation | 01:10 | T | 25A | Elevation of wall 2502 and west-facing section   |
| 136 | Plan      | 01:20 | T | 25C | Post-ex plan of Trench 25C   |
| 137 | Elevation | 01:10 | T | 25C | West-facing profile/section  |
| 138 | Elevation | 01:10 | T | 25C | North-facing profile   |
| 139 | Section   | 01:10 | T | 25B | South-facing section   |
| 140 | Section   | 01:10 | T | 25B | West-facing section  |
| 141 | Section   | 01:10 | T | 25B | East-facing section  |
| 142 | Section   | 01:10 | T | 25B | North-facing section   |
| 143 | Plan      | 01:20 | T | 25A | Post-ex plan of Trench 25A, showing 2508, 2502, 2506, 2513                                 |
| 144 | Plan      | 01:20 | E | 26A | Surfaces of 2604, 2605, 2606, 2607   |
| 145 | Section   | 01:10 | T | 25C | South-facing section   |
| 146 | Section   | 01:10 | T | 25A | North-facing section   |

|     |           |       |   |     |  |
|-----|-----------|-------|---|-----|--|
| 147 | Section   | 01:10 | T | 25A | West-facing section - outside building   |
| 148 | Plan      | 01:20 | E | 26A | Post-ex plan of surface 2607   |
| 149 | Elevation | 01:10 | T | 25A | East-facing elevation of eastern wall, missing keystone                                    |
| 150 | Elevation | 01:10 | T | 25A | South-facing elevation of northern wall  |
| 151 | Section   | 01:10 | E | 26A | South-facing section   |
| 152 | Section   | 01:10 | E | 26A | West-facing section  |
| 153 | Section   | 01:10 | E | 26A | North-facing section   |
| 154 | Plan      | 01:20 | T | 21  | Post-ex plan of Trench 21, cobbles   |
| 155 | Section   | 01:10 | D | 29  | West-facing section  |
| 156 | Plan      | 01:20 | D | 29  | Post-ex plan of Trench 29  |
| 157 | Plan      | 01:20 | E | 26B | Mid-ex plan of Trench 26B, showing 2608, 2609, 2610, 2611, 2612                            |
| 158 | Plan      | 01:20 | T | 25B | Post-ex plan of Trench 25B, showing 2527, 2525, 2524, 2526, 2523                           |
| 159 | Section   | 01:10 | G | 11  | North-facing section   |
| 160 | Plan      | 01:20 | G | 11  | Post-ex plan of Trench 11  |
| 161 | Plan      | 01:20 | T | 22A | Plan of Trench 22A, after removal of 2205, 2206  |
| 162 | Plan      | 01:20 | E | 26B | Post-ex plan of Trench 26B, following removal of 2610, 2611, 2612, showing surface of 2613 |
| 163 | Plan      | 01:20 | T | 22A | Mid-ex plan of Trench 22A  |
| 164 | Plan      | 01:20 | T | 22C | Plan of Trench 22C, following removal of topsoil   |
| 165 | Plan      | 01:20 | T | 22B | Plan of trench 22B, showing metallised surface   |
| 166 | Section   | 01:20 | T | 28  | North-facing section   |
| 167 | Plan      | 01:20 | T | 28  | Post-ex plan of Trench 28, showing 2808, 2810, 2813  |
| 168 | Plan      | 01:20 | E | 26B | Post-ex plan of Trench 26B   |
| 169 | Section   | 01:10 | E | 26B | North-facing section   |
| 170 | Section   | 01:10 | E | 26B | East-facing section  |
| 171 | Section   | 01:10 | T | 22A | East-facing section, post-ex   |
| 172 | Section   | 01:10 | T | 22A | North-facing section, post-ex  |
| 173 | Plan      | 01:20 | T | 30A | Plan of cobbled surface revealed after removal of topsoil/rubble layer                     |
| 174 | Section   | 01:10 | T | 22A | West-facing section, post-ex   |
| 175 | Plan      | 01:20 | T | 22A | Post-ex plan of Trench 22A   |
| 176 | Section   | 01:10 | T | 30A | North-facing section   |

|     |           |       |   |     |   |
|-----|-----------|-------|---|-----|---|
| 177 | Section   | 01:10 | T | 22C | East-facing section   |
| 178 | Plan      | 01:20 | T | 22C | Post-ex plan of Trench 22C  |
| 179 | Plan      | 01:20 | T | 30C | Post-ex plan of Trench 30C, showing cobbles   |
| 180 | Section   | 01:10 | T | 30C | West-facing section   |
| 181 | Plan      | 01:20 | T | 22B | Post-ex plan of Trench 22B  |
| 182 | Elevation | 01:10 | E | 26B | Profile through walls C.2608  |
| 183 | Plan      | 01:20 | T | 30B | Post-ex plan of Trench 30B, showing cobbles   |
| 184 | Section   | 01:10 | T | 30B | West-facing section   |
| 185 | Plan      | 01:20 | T | 30D | Post-ex plan of Trench 30D  |
| 186 | Section   | 01:10 | T | 30D | West-facing section   |
| 187 | Section   | 01:10 | T | 22B | South-facing section, post-ex   |
| 188 | Plan      | 01:20 | T | 30E | Post-ex plan of Trench 30E, showing exposed stones  |
| 189 | Section   | 01:10 | G | 11  | North-facing section  |
| 190 | Section   | 01:10 | T | 30E | South-facing section  |
| 191 | Section   | 01:10 | G | 11  | North-facing section  |
| 192 | Plan      | 01:20 | T | 21  | Post-ex plan of Trench 21, showing cobbles  |
| 193 | Section   | 01:10 | T | 22B | North-facing section, post-ex   |
| 194 | Plan      | 01:20 | T | 30F | Post-ex plan of Trench 30F, showing 3004  |
| 195 | Plan      | 01:20 | G | 11  | Post-ex plan of Trench 11   |
| 196 | Section   | 01:10 | T | 21  | Sections of box trench, north-west corner of trench, facing west                                    |
| 197 | Section   | 01:10 | T | 30F | North-facing section  |
| 198 | Plan      | 01:20 | T | 30G | Post-ex plan of Trench 30G  |
| 199 | Section   | 01:10 | T | 30G | South-facing section  |
| 200 | Section   | 01:10 | T | 32  | East-facing section   |
| 201 | Plan      | 01:20 | T | 32  | Post-ex plan of Trench 32   |
| 202 | Plan      | 01:20 | T | 31  | Plan of Trench 31, showing 3102 (stone and gravel layer)  |
| 203 | Plan      | 01:20 | T | 30H | Mid-ex plan of Trench 30H, showing bedrock and rubble collapse/levelling deposit. Without extension |
| 204 | Section   | 01:10 | T | 30H | East-facing section, without extension  |
| 205 | Plan      | 01:20 | T | 31  | post-ex plan of trench 31, showing section (east-west) through 3102 (stone and gravel layer)        |

|     |         |       |   |     |  |
|-----|---------|-------|---|-----|--|
| 206 | Section | 01:10 | T | 31  | South-facing section   |
| 207 | Plan    | 01:20 | T | 30H | Post-ex plan of Trench 30H, with extension                     |
| 208 | Section | 01:10 | T | 30H | East-facing section, with extension                            |
| 209 | Plan    | 01:20 | T | 30D | Post-ex plan of Trench 30D, showing subsoil                    |
| 210 | Section | 01:10 | T | 30D | West-facing section, post-ex, showing 3000, 3001, 3002, 3012   |
| 211 | Section | 01:10 | G | 10  | North-facing section   |
| 212 | Plan    | 1:20  | T | 30H | Post-ex plan of Trench 30H, after extension and half sectioned |

## APPENDIX 4: PHOTOGRAPHIC REGISTER

| Photo No: | Description   |
|-----------|---|
| 5441      | Pre-ex of trench 2, looking north                                       |
| 5442      | Pre-ex of trench 2, looking north                                       |
| 5443      | Cutting the first sod   |
| 5444      | Cutting the first sod   |
| 5445      | Pre-ex of trench 1, looking north                                       |
| 5446      | Pre-ex of trench 1, looking north                                       |
| 5447      | Pre-ex of trench 4, looking north                                       |
| 5448      | Pre-ex of trench 4, looking north                                       |
| 5449      | trench 1, surface of C.101, looking south                               |
| 5450      | Trench 2, surface of C.201, looking south                               |
| 5451      | Trench 4, surface of C.401, looking south                               |
| 5452      | Trench 4, surface of C.401, looking south                               |
| 5453      | Trench 1, cobbled surface of C.103) looking south                       |
| 5454      | Trench 1, cobbled surface of C.103) looking East                        |
| 5455      | Trench 2, surface of C.202 looking                                      |
| 5456      | Trench 2, surface of C.202 looking                                      |
| 5457      | Trench 4, cobbled surface C.402 looking                                 |
| 5458      | Trench 4, cobbled surface C.402 looking                                 |
| 5459      | Trench 5, pre-ex looking south-east                                     |
| 5460      | Trench 5, pre-ex looking north-west                                     |
| 5461      | Pre-ex of trench 16 looking north                                       |
| 5462      | Pre-ex of trench 16 looking north                                       |
| 5463      | Pre-ex of trench 8 looking north  |
| 5464      | Pre-ex of trench 8 looking north  |
| 5465      | Desodding trench 8  |
| 5466      | Desodding trench 8  |
| 5467      | Desodding trench 16   |
| 5468      | Trench 5 following removal of scrub, looking south-east                 |
| 5469      | West facing section of trench 4   |
| 5470      | West facing section of trench 4, close up                               |
| 5471      | Trench 5 following removal of C.502 showing subsoil, Looking south-east |
| 5472      | Trench 5 following removal of C.502 showing subsoil, Looking south-east |
| 5473      | Post-ex of trench 2 showing cobbles, looking south                      |
| 5474      | Post-ex of trench 2 showing cobbles, looking south                      |
| 5475      | West facing section of trench 2   |
| 5476      | West facing section of trench 2   |
| 5477      | Trench 5 prior to extension looking south-east                          |
| 5478      | Trench 5 prior to extension looking north-west                          |
| 5479      | Trench 16 following removal of C.1600, looking North                    |
| 5480      | Trench 16 following removal of C.1600, looking North                    |
| 5481      | Trench 16 following removal of C.1600, looking South                    |
| 5482      | Trench 16 following removal of C.1600, looking South                    |
| 5483      | Pre-ex of trench 5, looking south-east                                  |
| 5484      | Pre-ex of trench 5, looking north-west                                  |
| 5485      | Pre-ex of trench 5, looking north                                       |
| 5486      | Trench 5, close up of cobbles C.501 in section                          |
| 5487      | Trench 8, pre-ex looking north  |
| 5488      | Trench 8, pre-ex looking east   |
| 5489      | Trench 8, pre-ex showing stones, looking east                           |
| 5515      | Trench 5 after backfilling, looking south                               |
| 5516      | Trench 8, working shot  |
| 5517      | Trench 8, working shot  |
| 5518      | Trench 8 following removal of topsoil C.801, looking south              |
| 5519      | Trench 8 following removal of topsoil C.801, looking west               |
| 5520      | Trench 8 following removal of topsoil C.801, looking east               |
| 5521      | Trench 8 following removal of topsoil C.801, looking north              |
| 5522      | Trench 16 after removal of topsoil looking north                        |



5523 Trench 16 after removal of topsoil looking north-east  
5524 Trench 16, cobbled surface C.1604, looking north-east  
5525 Trench 16, cobbles C.1604, looking west  
5526 Trench 16, bank C.1605, looking south  
5527 Trench 16, bank C.1605, looking south - close up  
5528 Trench 16, bank C.1605, looking south - close up  
5529 Trench 16 after removal of topsoil, looking north  
5530 Trench 16 after removal of topsoil, looking north  
5531 Trench 16 after removal of topsoil, looking north  
5532 Trench 16 after removal of topsoil, looking north  
5533 Trench 16 after removal of topsoil, looking north  
5534 Trench 16, cobbled surface C.1604, looking west  
5535 Trench 16, cobbled surface C.1604, looking west  
5536 Trench 16, cobbled surface C.1604, looking south  
5537 Trench 16, after removal of cobbles, looking south  
5538 Trench 16, bank C.1605, looking south  
5539 Trench 16, cobbled surface C.1604, looking north  
5540 Trench 16, looking north-east  
5541 Trench 16, cobbles C.1604, looking south  
5542 Trench 16, looking north-east  
5543 Trench 16, looking north-east  
5544 Trench 8, C.802 looking south  
5545 Trench 8, C.802 looking west  
5546 Trench 8, C.802 looking south  
5547 Trench 8, C.802 looking south  
5548 Trench 8, C.802 looking north  
5549 Trench 8, C.802 looking east  
5550 Trench 8, photo of cut stone from C.802  
5551 Trench 7, photo of C.702 at end of day, looking south  
5552 Trench 7, photo of C.702 at end of day, looking south  
5553 Trench 7, photo of C.702 at end of day, looking north  
5554 Trench 7, photo of C.702 at end of day, looking north  
5555 Trench 8, sondage cut through C.802  
5556 Trench 8, sondage cut through C.802  
5558 Photos of floor tiles and other artefacts  
5559 Photos of floor tiles and other artefacts  
5560 Photos of floor tiles and other artefacts  
5561 Photos of floor tiles and other artefacts  
5562 Photos of floor tiles and other artefacts  
5563 Photos of floor tiles and other artefacts  
5564 Photos of floor tiles and other artefacts  
5565 Photos of floor tiles and other artefacts  
5566 Photos of floor tiles and other artefacts  
5567 Photos of floor tiles and other artefacts  
5568 Photos of floor tiles and other artefacts  
5569 Photos of floor tiles and other artefacts  
5570 Trench 7, northern half of trench showing C.702, looking south  
5571 Trench 7, northern half of trench showing C.702, looking north  
5572 Trench 7, close up of stones C.702, looking south  
5573 Trench 8, half section through C.802, looking south  
5574 Trench 8, half section through C.802, looking north  
5575 Trench 8, half section through C.802, looking south  
5576 Trench 8, half section through C.802, looking west  
5577 Trench 16, excavating the wall  
5578 Trench 16, excavating the wall  
5579 Trench 16, excavating the wall  
5580 Trench 16, north face of the wall  
5581 Trench 16, north face of the wall  
5582 Trench 16, north face of the wall  
5583 Trench 16, after removal of first layer of demolition  
5584 Trench 16, north face of the wall  
5585 Trench 16, north face of the wall

5586 Trench 16, north face of the wall  
5587 Trench 16, north face of the wall  
5588 Trench 16, north face of the wall  
5589 Trench 16, north face of the wall  
5590 Trench 16, north face of the wall  
5591 Trench 16, south face of wall and cobbles, looking north  
5592 Trench 16, south face of wall and cobbles, looking north  
5593 Trench 16, south face of wall and cobbles, looking north  
5594 Trench 16, south face of wall and cobbles, looking north  
5595 Trench 16, south face of wall and cobbles, looking north  
5596 Trench 16, south face of wall and cobbles, looking north  
5597 Trench 16, south face of wall and cobbles, looking north  
5598 Trench 16, south face of wall  
5599 Trench 16, wall looking west  
5600 Trench 16, wall looking west  
5601 Trench 16, wall looking west  
5602 Trench 16, wall looking west  
5603 Trench 16, surface of C.1603 following extension, looking north  
5604 Trench 16, surface of C.1603 following extension, looking north  
5605 Trench 13B, after removal of sod C.1300, looking north  
5606 Trench 13B, after removal of sod, looking south  
5607 Trench 7, showing possible collapse of stone wall C.702, looking south  
5608 Trench 7, showing possible collapse of stone wall C.702, looking south  
5609 Trench 7, showing possible collapse of stone wall C.702, looking north  
5610 Trench 7, showing possible collapse of stone wall C.702, looking north  
5611 Trench 7, possible surface of stone wall  
5622 Trench 13, south facing view of exposed C.1302  
5623 Trench 13, north facing view of exposed C.1302  
5624 Trench 13, close up of was C.1307  
5625 Trench 8, following removal of C.804 in half section, looking south  
5626 Trench 8, close up of half section following removal of C804, looking south  
5627 Trench 8, close up of half section following removal of C804, looking north  
5628 Trench 8, close up of half section looking north  
5629 Trench 16, wall C.1607 and clay C.1609, looking north  
5630 Trench 16, wall C.1607 and clay C.1609, looking south  
5631 Trench 16, wall C.1607 and clay C.1609, looking north  
5632 Trench 16, wall C.1607 and clay C.1609, looking north  
5633 Trench 16, wall C.1607 and clay C.1609, looking north  
5634 Trench 16, wall C.1607 and clay C.1609, looking north  
5635 Trench 14, after removal of topsoil showing C.1402, looking east  
5636 Trench 14, after removal of topsoil showing C.1402, looking east  
5637 Trench 14, after removal of topsoil showing C.1402, looking east  
5638 Trench 8, after excavation of sondage , looking south  
5639 Trench 8, after excavation of sondage , looking south  
5640 Trench 8, after excavation of sondage , looking north  
5641 Trench 8, after excavation of sondage , looking north  
5642 Trench 13B, after excavation of C.1301, 1302 and western half of trench, looking north  
5643 Trench 13B, after excavation of C.1301, 1302 and western half of trench, looking north  
5644 Trench 13B, after excavation of C.1301, 1302 and western half of trench, looking north  
5645 Trench 13B, after excavation of C.1301, 1302 and western half of trench, looking north  
5646 Trench 13B, following removal of wall collapse C.1302, looking south  
5647 Trench 13B, following removal of wall collapse, close up of soil Variations, looking south  
5648 Trench 14, after removal of C.1402, looking west  
5649 Trench 14, after removal of C.1402, looking west  
5650 Trench 14, after removal of C.1402, looking east  
5651 Trench 14, after removal of C.1402, looking east  
5652 Garden and village fields taken from western field  
5653 Garden and village fields taken from western field  
5654 Garden and village fields taken from western field  
5655 Garden and village fields taken from western field  
5656 Garden and village fields taken from western field  
5657 Garden and village fields taken from western field

5658 Garden and village fields taken from western field  
5659 Garden and village fields taken from western field  
5660 Trench 14, possible wall, looking west  
5661 Trench 14, possible wall, looking west  
5662 Trench 14, possible wall, looking north  
5663 Trench 13B, following removal of rubble C.1302 and C.1303 following possible path, looking south  
5664 Trench 13B, following removal of rubble C.1302 and C.1303 following possible path, looking south  
5665 Trench 8, post-ex of subsoil, looking south  
5666 Trench 8, post-ex of subsoil, looking south  
5667 Trench 8, following removal of C.802, looking south  
5668 Trench 7, following removal of C.702, looking south  
5669 Trench 7, following removal of C.702, looking south  
5670 Trench 7, following removal of C.703, looking south  
5671 Trench 7, following removal of C.703, looking south  
5672 Trench 16  
5673 Trench 16  
5674 Trench 16  
5675 Trench 16  
5676 Trench 16  
5677 Trench 16  
5678 Trench 16  
5679 Trench 16  
5680 Trench 13, post-ex  
5681 Trench 13, post-ex  
5682 Elevation of wall C.1307  
5683 Elevation of wall C.1307  
5684 Trench 8, south facing section, looking north  
5685 Trench 8, south facing section, looking north  
5686 Trench 8, north facing section, looking south  
5687 Trench 8, north facing section, looking south  
5688 Trench 8, east facing section, looking west  
5689 Trench 8, east facing section, looking west  
5690 Trench 8, west facing section, looking east  
5691 Trench 8, west facing section, looking east  
5694 Trench 13B, west facing section  
5695 Trench 13B, west facing section  
5696 Trench 13B, west facing section  
5697 Trench 13B, north facing section  
5698 Trench 13B, south facing section  
5699 Trench 13B, east facing section  
5700 Trench 13B, east facing section  
5701 Trench 13B, east facing section  
5710 Foggy morning at dunluce  
5711 Trench 13A, pre-ex, looking east  
5712 Trench 13A, pre-ex, looking west  
5713 Trench 14, post-ex of wall, looking west  
5714 Trench 14, post-ex of wall, looking west  
5715 Trench 14, post-ex of wall, looking south  
5716 Trench 14, post-ex of wall, looking south  
5717 Trench 14, post-ex of wall, looking east  
5718 Trench 14, post-ex of wall, looking east  
5719 Trench 14, post-ex of wall, south facing section  
5720 Trench 14, post-ex of wall, south facing section  
5721 Trench 14, post-ex, south facing section, close up  
5722 Trench 14, post-ex, south facing section, close up  
5723 Trench 14, post-ex, north facing section, close up  
5724 Trench 14, post-ex, overhead of wall, looking south  
5725 Trench 14, post-ex, overhead of wall, looking south  
5726 Trench 14, post-ex, overhead of wall, looking west  
5727 Trench 14, post-ex, east facing section  
5728 Trench 14, post-ex, east facing section  
5729 Trench 14, post-ex, west facing section

5730 Trench 14, post-ex, west facing section  
5731 Castle, Tuesday afternoon  
5732 Castle, Tuesday afternoon  
5733 Castle, Tuesday afternoon  
5734 Castle, Tuesday afternoon  
5773 Trench 9, photo of grey clay behind wall arbitrary split, looking south  
5774 Trench 9, photo of grey clay behind wall arbitrary split, looking south  
5775 Trench 7, mid excavation photo during removal of C.704, north of wall, looking south  
5776 Trench 7, mid excavation photo during removal of C.704, north of wall, looking north  
5777 Trench 7, mid excavation photo during removal of C.704, north of wall, looking north  
5778 Trench 7, dark patch in C.707 north of wall  
5779 Trench 7, dark patch in C.707 north of wall  
5780 Trench 16, slot trench C.1610, following excavation, looking south  
5781 Trench 16, slot trench C.1610, following excavation, looking south  
5782 Trench 16, slot trench C.1610, following excavation, looking south  
5783 Trench 16, slot trench C.1610, following excavation, looking south  
5784 Trench 13A, metalled surface west of wall C.1314  
5785 Trench 13A, metalled surface west of wall C.1314  
5786 Trench 16, post-ex, looking south with ranging rods  
5787 Trench 16, post-ex, looking south with ranging rods  
5788 Trench 16, post-ex, looking south with ranging rods  
5789 Trench 16, post-ex, looking south with ranging rods  
5790 Trench 16, post-ex, looking south with ranging rods  
5791 Trench 16, post-ex, looking south with ranging rods  
5792 Trench 16, post-ex, looking south with ranging rods  
5793 Trench 16, post-ex, looking south with ranging rods  
5794 Trench 16, post-ex, looking south with ranging rods  
5795 Trench 16, post-ex, looking south with ranging rods  
5796 Detail of cut for cobbles C.1613, looking north  
5797 Detail of cut for cobbles C.1613, looking north  
5798 Trench 16, aerial photo of road  
5799 Trench 16, aerial photo of road  
5800 Trench 16, aerial photo of road  
5801 Trench 16, aerial photo of road  
5802 Trench 16, aerial photo of road  
5803 Trench 16, aerial photo of road  
5804 Trench 16, aerial photo of road  
5805 Trench 16, aerial photo of road  
5806 Trench 16, aerial photo of road  
5807 North face of wall C.1607  
5808 North face of wall C.1607  
5809 North face of wall C.1607  
5810 North face of wall C.1607  
5811 North face of wall C.1607  
5812 North face of wall C.1607  
5813 Gully, jostle stone features  
5814 Gully, jostle stone features  
5815 Gully, jostle stone features  
5816 Gully, jostle stone features  
5817 Gully, jostle stone features  
5818 Gully, jostle stone features  
5819 Gully, jostle stone features  
5820 Gully, jostle stone features  
5821 Trench 7, east facing section south of wall  
5822 Trench 7, east facing section south of wall  
5823 Trench 7, west facing section south of wall  
5824 Trench 7, west facing section south of wall  
5825 Trench 7, north facing section south of wall  
5826 Trench 7, north facing section south of wall  
5827 Trench 7, east facing section south of wall, with ranging rods  
5828 Trench 7, east facing section south of wall, with ranging rods  
5829 Trench 7, west facing section south of wall, with ranging rods

5830 Trench 7, west facing section south of wall, with ranging rods  
5831 Trench 7, north facing section south of wall, with ranging rods  
5832 Trench 7, north facing section south of wall, with ranging rods  
5833 Trench 7, west facing, showing cut through C.708 for wall  
5834 Trench 7, west facing, showing cut through C.708 for wall, with ranging rods  
5835 Trench 14, south facing, depth of C.1408  
5838 Trench 14, sondage through natural  
5839 Trench 16, east facing section  
5840 Trench 16, east facing section  
5841 Trench 16, east facing section  
5842 Trench 16, east facing section  
5843 Trench 16, east facing section  
5844 Trench 16, east facing section  
5845 Trench 16, east facing section  
5846 Trench 16, east facing section  
5847 Trench 16, east facing section  
5848 Trench 16, east facing section  
5849 Trench 16, east facing section  
5850 Trench 16, east facing section, with ranging rods  
5851 Trench 16, east facing section, with ranging rods  
5852 Trench 16, east facing section, with ranging rods  
5853 Trench 16, east facing section, with ranging rods  
5854 Trench 16, east facing section, with ranging rods  
5855 Trench 16, east facing section, with ranging rods  
5856 Trench 16, east facing section, with ranging rods  
5857 Trench 16, east facing section, with ranging rods  
5858 Trench 16, east facing section, with ranging rods  
5859 Trench 16, east facing section, with ranging rods  
5860 Trench 16, east facing section, with ranging rods  
5861 Trench 16, east facing section, with ranging rods  
5862 Trench 9B, following removal of sod, looking south  
5863 Trench 9B, following removal of sod, looking north  
5864 Trench 13A, showing south facing section  
5865 Trench 13A, looking east  
5866 Trench 13A, looking west  
5867 Trench 13A, showing cut C.1325  
5868 Trench 8, proof of covering before backfill  
5869 Trench 8, proof of covering before backfill  
5870 Trench 9B, following removal of topsoil, looking south  
5871 Trench 9B, following removal of topsoil, looking north  
5872 Trench 9B, wall collapse in north of trench with mortar, looking south  
5873 Trench 9B, surface of wall C.903, looking south  
5874 Trench 9B, surface of wall C.903, looking east  
5875 Trench 15B, after removal of topsoil, looking west  
5876 Trench 15B, after removal of topsoil, looking north  
5877 Trench 15A, after removal of topsoil, looking east  
5878 Trench 15A, after removal of topsoil, looking east  
5880 Trench 7, articulated bone in C.707 north of wall, looking south  
5881 Trench 7, articulated bone in C.707 north of wall, looking west  
5882 Survey field – west corner facing up hill  
5883 Survey field – from gate, looking east up hill  
5884 Survey field – south mid-section along road, facing towards car park  
5885 Survey field – South-east corner looking along road  
5886 Survey field – south-east corner looking north along fence  
5887 Survey field – east along car park fence looking west  
5888 Survey field – north-east corner of car park looking west  
5889 Survey field – north-east looking centre field  
5890 Survey field – north-east looking centre field  
5891 Survey-field – north, looking downfield  
5892 Survey-field – north, looking downfield  
5893 Survey-field – north, daisy feature along north edge of field, looking east  
5894 Survey-field – north, daisy feature along north edge of field, looking east

5895 Survey-field – north, daisy feature along north edge of field, looking east  
5896 Survey-field – north, track way down to stream, looking east  
5897 Survey-field – north corner towards road, showing uphill  
5898 Survey-field – north corner towards road, showing uphill  
5899 Survey-field – west, showing field drop-off  
5900 Survey-field – west, looking uphill towards centre  
5901 Survey-field – centre of field, top of mound, facing car park  
5902 Survey-field – centre of field, top of mound, facing car park  
5903 Survey-field – centre of field, top of mound, facing field gate  
5904 Survey-field – centre of field, top of mound, looking west  
5905 Survey-field – centre of field, top of mound, facing north-west corner  
5906 Survey-field – showing mound top in centre of field  
5907 Trench 13A, south facing section extension  
5908 Trench 13A, south facing section extension  
5909 Trench 13A, north facing section extension  
5910 Trench 13A, north facing section extension  
5911 Trench 20, surface of C.2001, looking east  
5912 Trench 20, surface of C.2001, looking east  
5913 Trench 20, surface of C.2001, looking west  
5914 Trench 20, surface of C.2001, looking west  
5915 Trench 20, surface of C.2001,C.2002, C.2003, looking east  
5916 Trench 20, surface of C.2001,C.2002, C.2003, looking east  
5917 Trench 20, surface of C.2001,C.2002, C.2003, looking east  
5918 Trench 20, surface of C.2001,C.2002, C.2003, looking east  
5919 Trench 9B, following removal of rubble collapse C.906, C.907, looking south  
5920 Trench 9B, following removal of rubble collapse C.906, C.907, looking south  
5921 Trench 9B, following removal of rubble collapse C.906, C.907, looking north  
5922 Trench 9B, following removal of rubble collapse C.906, C.907, looking north  
5923 Trench 9B, Surface of C.902 following removal of rubble, looking north-west  
5924 Trench 9B, surface of C.903, looking south  
5925 Trench 9B, surface of C.905, looking south  
5926 Trench 15B, after partial removal of C.1503, looking west  
5927 Trench 15B, after partial removal of C.1503, looking east  
5928 Trench 15B, after partial removal of C.1503, looking west  
5929 Trench 7, following removal of C.707 on to natural, looking south  
5930 Trench 7, following removal of C.707 on to natural, looking south  
5931 Trench 7, following removal of C.707 on to natural, looking north  
5932 Trench 7, following removal of C.707 on to natural, looking north  
5933 Trench 7, Surface of C.714 and cut C.713, looking south  
5934 Trench 7, Surface of C.714 and cut C.713, looking north  
5935 pre-ex of C.712, looking south  
5936 pre-ex of C.712, looking north  
5937 Trench 13A, south facing extension of trench  
5938 Trench 13A, south facing extension of trench  
5939 Mid excavation C.712, looking north  
5940 Mid excavation C.712, looking south  
5941 North extension Trench 13A, post-ex, looking north  
5942 North extension Trench 13A, post-ex, looking south  
5943 North extension Trench 13A, post-ex, looking south  
5944 Trench 7, Mid excavation C.714, looking south  
5945 Trench 7, Mid excavation C.714, looking north  
5946 Trench 7, Mid excavation C.714, looking north  
5947 Trench 20, following removal of C.2001, c.2003, looking west  
5948 Trench 20, following removal of C.2001, c.2003, looking west  
5949 Trench 20, following removal of C.2001, c.2003, looking east  
5950 Trench 20, following removal of C.2001, c.2003, looking east  
5954 Trench 20  
5955 Trench 20  
5956 Trench 20  
5957 Trench 20  
5958 Trench 7, post-ex shot of C.715, looking south  
5959 Trench 7, post-ex shot of C.715, looking north

5960 Trench 7, post-ex shot of C.713, looking south  
5961 Trench 7, post-ex shot of C.713, looking north  
5962 Artefact Photos  
5963 Artefact Photos  
5964 Artefact Photos  
5965 Artefact Photos  
5966 Artefact Photos  
5967 Artefact Photos  
5968 Artefact Photos  
5969 Artefact Photos  
5970 Artefact Photos  
5971 Artefact Photos  
5972 Artefact Photos  
5973 Artefact Photos  
5974 Artefact Photos  
5975 Artefact Photos  
5976 Artefact Photos  
5977 Artefact Photos  
5978 Artefact Photos  
5979 Artefact Photos  
5980 Artefact Photos  
5981 Artefact Photos  
5982 Trench 15B, after complete removal of C.1503, looking east  
5983 Trench 15B, after complete removal of C.1503, looking west  
5985 Trench 15B, after removal of C.1503, looking east  
5986 Trench 15B, after removal of C.1503, looking west  
5987 Photos of sealing stamp  
5988 Photos of sealing stamp  
5989 Photos of sealing stamp  
5990 Photos of sealing stamp  
5991 Photos of sealing stamp  
5992 Trench 9B, half section through path, looking south  
5993 Trench 9B, half section through path, looking north  
5994 Artefact photos  
5995 Artefact photos  
5996 Artefact photos  
5997 Artefact photos  
5998 Artefact photos  
5999 Artefact photos  
6000 Artefact photos  
6001 Artefact photos  
6002 Artefact photos  
6003 Artefact photos  
6004 Artefact photos  
6005 Artefact photos  
6006 Artefact photos  
6007 Artefact photos  
6008 Artefact photos  
6009 Artefact photos  
6010 Trench 20, surfaces of C.2002, c.2006, c.2008, c.2009, looking west  
6011 Trench 20, surfaces of C.2002, c.2006, c.2008, c.2009, looking west  
6012 Trench 20, surfaces of C.2002, c.2006, c.2008, c.2009, looking east  
6013 Trench 20, surfaces of C.2002, c.2006, c.2008, c.2009, looking east  
6014 Trench 15B, looking west, post-ex  
6015 Trench 15B, looking west, close up of east section, post-ex  
6016 Trench 15B, looking east, close up of east section, post-ex  
6017 Mid excavation photo of C717 looking south  
6018 Mid excavation photo of C717 looking south  
6019 Mid excavation photo of C717 looking south  
6020 Mid excavation photo of C717 looking south  
6021 Mid excavation photo of C717 looking south  
6022 Trench 15a, north facing section, (west photo 1 of 2)

6023 Trench 15a, north facing section, (east photo 2 of 2)  
6024 Trench 15a, post-ex, looking west  
6025 Trench 15a, post-ex, looking east  
6026 Trench 7, cut C.718 post-ex, looking south  
6027 Trench 20, following removal of C.209, looking east  
6028 Trench 20, following removal of C.209, looking east  
6029 Trench 20, following removal of C.209, looking west  
6030 Trench 20, following removal of C.209, looking west  
6031 Trench 23C, following removal of topsoil, looking east  
6032 Trench 23C, following removal of topsoil, looking west  
6033 Trench 7, post-ex of cut C.718, looking south  
6034 Trench 7, post-ex of cut C.718, looking south  
6035 Trench 9B, north of trench showing orange patch, charcoal, looking south  
6036 Trench 9B, north of trench showing orange patch, charcoal, looking south  
6037 Trench 9B, north of trench showing orange patch, charcoal, looking north  
6038 Trench 9B, north of trench showing orange patch, charcoal, looking north  
6039 Trench 9B, close up of charcoal orange patch, looking south  
6040 Trench 9B, foundation cut for C.905, looking south  
6041 Trench 9B, stone chippings in trench, looking west  
6042 Trench 9, working shot, looking south  
6043 Trench 9, orange brown charcoal deposit, looking south  
6044 Trench 9, orange brown charcoal deposit, looking south  
6045 Trench 9, orange brown charcoal deposit, looking north  
6046 Trench 9, close up of orange brown charcoal, looking south  
6047 Trench 9, post-ex shot of C.915, looking south  
6048 Trench 9, post-ex shot of C.915, looking east  
6049 Trench 12, removal of sod, looking south  
6050 Trench 12, removal of sod, looking north  
6051 Trench 7, post-ex, C.919, looking south  
6052 Trench 7, post-ex, C.919, looking north  
6053 Trench 7, post-ex, C.919, looking north  
6054 Trench 7, post-ex, C.919, looking south  
6055 Trench 7, post-ex, looking south  
6056 Trench 7, post-ex, looking south  
6057 Trench 7, post-ex, looking north  
6058 Trench 7, post-ex, looking north  
6059 Trench 7, post-ex of cut C.715, looking south  
6060 Trench 7, post-ex of cut C.715, looking north  
6061 Trench 7, post-ex of cut C.713, looking south  
6062 Trench 7, post-ex of cut C.713, looking north  
6063 Trench 7, post-ex surface of wall C.703, looking west  
6064 Trench 7, post-ex surface of wall C.703, looking west  
6065 Trench 7, post-ex surface of wall C.703, looking east  
6066 Trench 7, post-ex surface of wall C.703, looking east  
6067 Trench 7, post-ex northern face of wall C.703, looking south  
6068 Trench 7, post-ex northern face of wall C.703, looking south  
6069 Trench 7, post-ex southern face of wall C.703, looking north  
6070 Trench 7, post-ex southern face of wall C.703, looking north  
6071 Trench 7, post-ex north facing section, looking south  
6072 Trench 7, post-ex north facing section, looking south  
6073 Trench 7, post-ex north facing section, looking south  
6074 Trench 7, post-ex, west facing section, looking east  
6075 Trench 7, post-ex, west facing section, looking east  
6076 Trench 7, post-ex, west facing section, looking east  
6077 Trench 7, post-ex, west facing section, looking east  
6078 Trench 7, post-ex, west facing section, looking east  
6079 Trench 7, post-ex, west facing section, looking east  
6080 Trench 7, post-ex, west facing section, looking east  
6081 Trench 7, post-ex, west facing section, looking east  
6082 Trench 7, post-ex, west facing section, looking east  
6083 Trench 7, post-ex, west facing section, looking east with ranging rods  
6084 Trench 7, post-ex, west facing section, looking east with ranging rods



6085 Trench 7, post-ex, west facing section, looking east with ranging rods  
6086 Trench 7, post-ex, west facing section, looking east with ranging rods  
6087 Trench 7, post-ex, west facing section, looking east with ranging rods  
6088 Trench 7, post-ex, west facing section, looking east with ranging rods  
6089 Trench 7, post-ex, west facing section, looking east with ranging rods  
6090 Trench 7, post-ex, west facing section, looking east with ranging rods  
6091 Trench 7, post-ex looking south, midway up trench  
6092 Trench 7, post-ex looking south, midway up trench  
6093 Trench 7, post-ex, east facing section, looking west  
6094 Trench 7, post-ex, east facing section, looking west  
6095 Trench 7, post-ex, east facing section, looking west  
6096 Trench 7, post-ex, east facing section, looking west  
6097 Trench 7, post-ex, east facing section, looking west  
6098 Trench 7, post-ex, east facing section, looking west  
6099 Trench 7, post-ex, east facing section, looking west  
6100 Trench 7, post-ex, east facing section, looking west  
6101 Trench 7, post-ex, east facing section, looking west  
6102 Trench 7, post-ex, east facing section, looking west  
6103 Trench 7, post-ex, east facing section, looking west  
6104 Trench 7, post-ex, east facing section, looking west  
6105 Trench 7, post-ex, east facing section, looking west  
6106 Trench 7, post-ex, east facing section, looking west  
6107 Trench 20, following excavation of drain, cut C.2013, looking west  
6108 Trench 20, following excavation of drain, cut C.2013, looking west  
6109 Trench 20, following excavation of drain, cut C.2013, looking east  
6110 Trench 20, following excavation of drain, cut C.2013, looking east  
6111 Trench 20, drain cut C.2013, close up  
6112 Trench 20, drain cut C.2013, close up  
6113 Trench 9B, C916, C.917, south of wall C.905, looking north  
6114 Trench 9B, C916, C.917, south of wall C.905, looking north  
6115 Trench 9B, C916, C.917, south of wall C.905, looking south  
6118 Trench 9B, C.916, C.917, C.913 either side of wall C.905, looking east  
6120 Trench 9B, C.916, C.917, C.913 either side of wall C.905, looking south  
6121 Trench 9B, C.916, C.917, C.913 either side of wall C.905, looking south  
6122 Trench 9B, C.916, C.917, C.913 either side of wall C.905, looking east  
6123 Trench 9B, C.916, C.917, C.913 either side of wall C.905, looking east  
6124 Trench 9B, C.916, C.917, C.913 either side of wall C.905, looking east  
6126 Trench 7, post-ex, C.919 and C.918  
6127 Trench 7, post-ex, northern half of the trench, looking south  
6128 Trench 7, post-ex, northern half of the trench, looking south  
6129 Trench 7, post-ex, southern half of the trench, looking south  
6130 Trench 7, post-ex, middle of the trench, looking north  
6131 Trench 7, post-ex, terrace area, looking north  
6132 Trench 7, post-ex, terrace area, looking north  
6133 Trench 7, post-ex, terrace area, looking north  
6134 Trench 7, post-ex, north of the trench, looking south  
6135 Trench 7, post-ex, north of the trench, looking south  
6136 Trench 7, post-ex, south of the trench, looking south  
6137 Trench 7, middle of the trench, C.915, looking west  
6138 Trench 7, middle of the trench, C.915, looking west  
6142 Base of Trench 7, post-ex, C.919, C.918, looking East  
6143 Base of Trench 7, post-ex, C.915, looking East  
6144 Base of Trench 7, post-ex, looking East  
6145 Base of Trench 7, post-ex, C.913, looking East  
6146 Base of Trench 7, post-ex, C.903, looking East  
6147 Base of Trench 7, post-ex, looking East  
6148 Base of Trench 7, post-ex, C.903, looking East  
6149 Trench 9a, desodded, looking west  
6150 Trench 9a, desodded, looking east  
6151 Trench 9a, desodded, eastern half of the trench  
6152 Trench 23c, post-ex, looking west  
6153 Trench 23c, post-ex, looking east

6155 Trench 23c, north facing section, looking east  
6156 Trench 23c, north facing section, looking west  
6158 Trench 23c, south facing section, looking east  
6159 Trench 23c, south facing section, looking west  
6160 Trench 23c, east section  
6161 Trench 23b, pre-ex, after desodding  
6162 Trench 9b, pre-ex, C.916, C.917, C.905, looking north  
6163 Trench 9b, pre-ex, C.916, C.917, C.905, looking north  
6164 Trench 9b, pre-ex, C.916, C.917, C.905, looking north  
6165 Trench 9b, pre-ex, C.916, C.917, C.905, looking north  
6166 Trench 9b, pre-ex, C.916, C.917, C.905, looking north  
6167 Trench 9b, pre-ex, C.916, C.917, south side of C.905  
6168 Trench 9b, pre-ex, C.913, C.917, north side of C.906  
6169 Trench 9b, half section through C.916 to C.917, looking north  
6170 Trench 9b, half section through C.916 to C.917, looking north  
6171 Trench 9b, half section through C.916 to C.917, looking east  
6172 Trench 9b, half section through C.916 to C.917, looking north  
6173 Trench 9b, half section through C.916 to C.917, looking north  
6174 Trench 9b, half section through C.916 to C.917, looking south  
6175 Trench 9b, Anna digging out C.916, looking south  
6176 Trench 9b, Anna digging out C.916, looking south  
6177 Trench 20, following excavations of half sections, looking west  
6178 Trench 20, following excavations of half sections, looking west  
6179 Trench 20, following excavations of half sections, looking west, with ranging rods  
6180 Trench 20, following excavations of half sections, looking west, with ranging rods  
6181 Trench 20, following excavations of half sections, looking east  
6182 Trench 20, following excavations of half sections, looking east  
6183 Trench 20, following excavations of half sections, looking east, with ranging rods  
6184 Trench 20, following excavations of half sections, looking east, with ranging rods  
6185 Trench 20, close up of drain, in plan  
6186 Trench 20, close up of drain, in plan  
6187 Trench 20, close up of drain, in plan, with ranging rods  
6188 Trench 20, close up of drain, in plan, with ranging rods  
6189 Trench 20, aerial post-ex  
6190 Trench 20, aerial post-ex  
6191 Trench 20, aerial post-ex  
6192 Trench 20, aerial post-ex  
6193 Trench 9a, following removal of the topsoil, looking east  
6195 Trench 9a, following removal of the topsoil, looking east  
6196 Trench 9a, eastern half of trench following removal of the topsoil, looking east  
6197 Trench 9a, following removal of the topsoil, looking west  
6198 Trench 9b, surface of C.917 south of the wall, looking north  
6199 Trench 9b, surface of C.917 south of the wall, looking north  
6200 Trench 9b, surface of C.917 south of the wall, looking east  
6201 Trench 9b, surface of C.917 south of the wall, looking west  
6202 Trench 9b, surface of C.917 south of the wall, looking north  
6203 Trench 9b, surface of C.917 south of the wall, looking north  
6204 Artefact photos  
6205 Artefact photos  
6206 Artefact photos  
6207 Artefact photos  
6208 Artefact photos  
6209 Artefact photos  
6210 Artefact photos  
6213 Artefact photos  
6214 Artefact photos  
6216 Artefact photos  
6217 Artefact photos  
6218 Artefact photos  
6219 Artefact photos  
6220 Artefact photos  
6221 Artefact photos

|      |   |
|------|---|
| 6222 | Artefact photos   |
| 6223 | Artefact photos   |
| 6224 | Artefact photos   |
| 6225 | Artefact photos   |
| 6226 | Artefact photos   |
| 6227 | Artefact photos   |
| 6228 | Artefact photos   |
| 6229 | Artefact photos   |
| 6230 | Artefact photos   |
| 6231 | Artefact photos   |
| 6232 | Artefact photos   |
| 6233 | Artefact photos   |
| 6234 | Artefact photos   |
| 6235 | Artefact photos   |
| 6236 | Artefact photos   |
| 6238 | Artefact photos   |
| 6239 | Artefact photos   |
| 6240 | Artefact photos   |
| 6241 | Artefact photos   |
| 6242 | Artefact photos   |
| 6243 | Artefact photos   |
| 6244 | Artefact photos   |
| 6245 | Artefact photos   |
| 6246 | Artefact photos   |
| 6247 | Trench 12, surface of 1204 Looking south                        |
| 6248 | Trench 12, surface of 1204 Looking south                        |
| 6249 | Trench 12, surface of 1204 Looking south                        |
| 6250 | Trench 23b, mid-ex, looking south                               |
| 6251 | Trench 23b, mid-ex, looking south                               |
| 6252 | Trench 23b, mid-ex, looking west                                |
| 6253 | Trench 23b, mid-ex, looking east                                |
| 6254 | Trench 12, collapse slate and roof tile                         |
| 6255 | Trench 12, collapse slate and roof tile                         |
| 6256 | Trench 20, pre-ex of feature C.2017, in plan                    |
| 6257 | Trench 20, pre-ex of feature C.2017, in plan                    |
| 6258 | Trench 20, pre-ex of feature C.2017, in plan                    |
| 6259 | Trench 20, pre-ex of feature C.2017, in plan                    |
| 6260 | Trench 20, mid-ex of feature C.2017, looking west               |
| 6261 | Trench 20, mid-ex of feature C.2017, looking west               |
| 6262 | Trench 20, post-ex of feature C.2017, in plan                   |
| 6263 | Trench 20, post-ex of feature C.2017, in plan                   |
| 6264 | Trench 20, post-ex of feature C.2017, in plan                   |
| 6265 | Trench 20, post-ex of feature C.2017, in plan                   |
| 6266 | Trench 23b, mid-ex of wall collapse, looking east               |
| 6267 | Trench 23b, mid-ex of wall collapse, looking west               |
| 6268 | Trench 20, post-ex of full trench, looking west                 |
| 6269 | Trench 20, post-ex of full trench, looking west                 |
| 6270 | Trench 20, post-ex of full trench, looking west                 |
| 6271 | Trench 20, post-ex of full trench, looking east                 |
| 6272 | Trench 20, post-ex of full trench, looking east                 |
| 6273 | Trench 20, post-ex of full trench, looking east                 |
| 6274 | Trench 20, post-ex of drain C.2013, close up, in plan           |
| 6275 | Trench 20, post-ex of drain C.2013, close up, in plan           |
| 6276 | Trench 20, post-ex of drain C.2013, close up, in plan           |
| 6277 | Trench 20, post-ex of drain C.2013, close up, in plan           |
| 6278 | Trench 9a, minus sod and rubble, looking east                   |
| 6279 | Trench 9a, minus sod and rubble, looking east                   |
| 6280 | Trench 9a, mortar deposit in west of trench, looking south-west |
| 6281 | Trench 9a, top of wall, looking south                           |
| 6282 | Trench 9a, top of wall, looking north                           |
| 6283 | Trench 9a, showing wall, looking west                           |
| 6284 | Trench 9a, showing wall, looking west                           |

6285 Trench 9a, showing wall, looking west  
6286 Trench 9a, showing wall, looking west  
6287 Trench 9a, showing wall, looking west  
6288 Trench 12, C.1204, C.1205, looking south  
6290 Trench 12, C.1204, C.1205, looking north  
6291 Trench 10, pre-ex, looking south  
6292 Trench 10, pre-ex, looking south  
6293 Trench 10, pre-ex, sections cleaned, looking south  
6294 Trench 10, pre-ex, sections cleaned, looking south  
6295 Trench 9a, path, looking south  
6296 Trench 9a, path, looking south-west  
6297 Trench 9a, path, looking north  
6298 Trench 9a, path, looking north  
6299 Trench 9a, close up of path, looking east  
6300 Trench 17, following removal of C.1700 and C.1701, looking east  
6301 Trench 17, following removal of C.1700 and C.1701, looking east  
6302 Trench 17, following removal of C.1700 and C.1701, looking east  
6303 Trench 12, slate layer C.1205, in plan  
6304 Trench 12, slate layer C.1205, in plan  
6305 Trench 12, slate layer C.1205, in plan  
6306 Trench 12, slate layer C.1205, in plan  
6307 Trench 12, slate layer C.1205, in plan  
6308 Trench 9a, after removal of rubble, looking east  
6309 Trench 9a, after removal of rubble, looking east  
6310 Trench 9a, after removal of rubble, looking west  
6311 Trench 9a, after removal of rubble, looking west  
6312 Trench 9a, close up of wall, looking south  
6313 Trench 9a, close up of wall, looking south  
6314 Trench 9a, close up of wall, looking east  
6315 Trench 9a, close up of stones, looking south  
6316 Trench 9a, close up of stones, looking south  
6317 Trench 10, collapsed slate C.1002, C.1003, C.1001, looking south  
6318 Trench 10, collapsed slate C.1002, C.1003, C.1001, looking south  
6319 Trench 10, close up of collapsed slate C.1002, looking south  
6320 Trench 9, northern face of wall 905  
6321 Trench 23d, possible path, after removal of the topsoil, looking south  
6322 Trench 23d, possible path, after removal of the topsoil, looking north  
6323 Trench 9b, south facing elevation of northern wall  
6324 Trench 9b, south facing elevation of northern wall  
6325 Trench 9b, north facing elevation of southern wall  
6326 Trench 9b, north facing elevation of southern wall  
6327 Trench 9b, south facing elevation of southern wall  
6328 Trench 9b, south facing elevation of southern wall  
6329 Trench 9b, post-ex, looking north  
6330 Trench 9b, post-ex, looking north  
6332 Trench 9b, post-ex, looking south  
6333 Trench 9b, post-ex, looking south  
6334 Trench 9a, pre-ex of stones, looking south  
6335 Trench 9a, pre-ex of stones, looking south  
6336 Trench 9a, pre-ex of stones, looking south  
6337 Trench 17, following removal of C.1702, looking east  
6338 Trench 17, following removal of C.1702, looking east  
6339 Trench 17, following removal of C.1702, looking east  
6340 Trench 17, following removal of C.1702, looking east  
6341 Trench 23d, path C.2322 and burnt material, looking north  
6342 Trench 23d, path C.2322 and burnt material, looking north  
6343 Trench 12, after removal of C.1205 and C.1206, looking south  
6344 Trench 12, after removal of C.1205 and C.1206, looking south  
6345 Trench 12, after removal of C.1205 and C.1206, looking north  
6346 Trench 23d, path C.2322 and burnt material, looking north  
6347 Trench 23d, path C.2322 and burnt material, looking north  
6348 Trench 17, following removal of C.1703, looking east

6349 Trench 17, following removal of C.1703, looking east  
6350 Trench 17, following removal of C.1703, looking east  
6351 Trench 17, following removal of C.1703, looking east  
6352 Trench 12, north-west corner after section of C.1207, looking south  
6353 Trench 12, north-west corner after section of C.1207, looking south  
6354 Trench 12, north-west corner after section of C.1207, looking east  
6355 Trench 12, north-west corner after section of C.1207, looking west  
6356 Trench 9a, working surface, looking south  
6357 Trench 9a, working surface, looking south  
6358 Trench 9a, working surface, looking south  
6359 Trench 9a, working surface close up, looking west  
6360 Trench 9a, mid-ex, looking east  
6361 Trench 9a, mid-ex, looking east  
6362 Trench 9a, wall, looking south  
6363 Trench 9a, wall, looking north  
6364 Trench 9a, wall elevation, looking west  
6365 Trench 9a, wall, looking east  
6366 Trench 9a, stone feature, looking south  
6367 Trench 9a, stone feature, looking south  
6368 Trench 9a, stone feature, looking north  
6369 Trench 23d, post-ex, looking south  
6370 Trench 23d, post-ex, looking north  
6371 Trench 23d, east facing section  
6372 Trench 23d, west facing section  
6373 Trench 23d, north facing section  
6374 Trench 23b, wall, looking east  
6375 Trench 10, C.1003, looking south  
6376 Trench 10, C.1003, looking south  
6377 Trench 25a, C.2501, after removal of topsoil, looking west  
6378 Trench 25a, C.2501, after removal of topsoil, looking west  
6379 Trench 25a, C.2501, after removal of topsoil, looking east  
6380 Trench 25a, C.2501, after removal of topsoil, looking east  
6381 Trench 10, box trench, C.1004, C.1005, after removal of C.1002, looking south  
6382 Trench 10, box trench, C.1004, C.1005, after removal of C.1002, looking south  
6383 Trench 10, south section of the box trench, C.1004 after removal of C.1002, looking south  
6384 Trench 10, south section of the box trench, C.1004 after removal of C.1002, looking south  
6385 Trench 10, northern part of trench, C.1002, C.1005  
6386 Trench 10, northern part of trench, C.1006  
6387 Trench 9a, post-ex, looking east  
6388 Trench 9a, post-ex, looking east  
6389 Trench 9a, western 2/3rds of the trench, from wall C.928  
6390 Trench 9a, cut C.940, looking east  
6391 Trench 9a, fill C.937 at base of feature C.932, looking east  
6392 Trench 9a, fill C.937 at base of feature C.932, looking east  
6393 Trench 9a, fill C.938, looking north  
6394 Trench 9a, fill C.939, looking north  
6395 Trench 23a, post-ex  
6396 South facing section of trench 23a  
6397 East facing section of trench 23a  
6398 North facing section of trench 23a  
6399 East facing section of trench 23a  
6400 East facing section of trench 23a  
6401 West facing section of trench 23a  
6402 Trench 10, mid-ex, looking south  
6403 Trench 10, mid-ex close up of box trench, looking south  
6404 West facing section of Trench 10 (southern part of the trench)  
6405 North facing section of Trench 10 (section of box trench)  
6406 West facing section of Trench 10 (the whole of the trench)  
6407 Trench 9a, western end, looking east  
6408 Trench 9a, eastern end, looking west  
6409 Trench 9a, west of wall C.928, looking west  
6410 Trench 9a, east facing section, looking west

6411 Trench 9a, west facing section, looking east  
6412 Trench 9a, north facing section (western half), looking south  
6413 Trench 9a, north facing section, between wall features  
6414 Trench 9a, north facing section, eastern end  
6415 Trench 9a, south facing section, eastern end  
6416 Trench 9a, south facing section, eastern end  
6417 Trench 9a, south facing section between wall features  
6418 Trench 9a, south facing section, western end  
6419 Trench 25a, prior to backfilling southern half, looking south  
6420 Trench 25a, possible gable end in southern half, looking south  
6421 Trench 25a, possible gable end in southern half, looking south  
6422 Trench 9a, mid-ex, C.932, looking east  
6423 Trench 9a, post-ex, south facing section C.932  
6424 Trench 9a, post ex, north facing section C.933  
6425 Trench 9a, post-ex, feature C.932, looking east  
6426 Trench 25a, following removal of topsoil, looking west  
6427 Trench 25a, following removal of topsoil, looking west  
6428 Trench 25a, following removal of topsoil, looking north  
6429 Trench 25a, possible corner of house C.2502, looking north  
6430 Trench 25a, possible corner of house C.2502, looking west  
6431 Trench 25a, possible corner of house C.2502, looking south  
6432 Trench 12, during removal of C.1206, looking south  
6433 Trench 12, C.1208, north facing section, looking south  
6434 Trench 12, south end of trench, east facing section  
6435 Trench 12, south end of trench, during removal of C.1206  
6436 Trench 12, south end of trench, west facing section  
6437 Trench 12, south end of trench, during removal of C.1206, looking south  
6438 Trench 12, south end of trench, east facing section  
6439 Trench 12, south end of trench, west facing section  
6440 Trench 17, post-ex, looking east  
6441 Trench 17, south facing section  
6442 Trench 17, west facing section  
6443 Trench 17, west facing section  
6444 Trench 17, west facing section  
6445 Trench 12, during removal of C.1206, looking south  
6446 Trench 12, during removal of C.1206, looking south  
6447 Trench 12, during removal of C.1206, looking east  
6448 Trench 12, during removal of C.1206, looking north  
6449 Trench 25b, mid ex  
6450 Trench 25b, mid ex  
6451 Trench 25b, mid ex  
6452 Trench 25b, mid ex  
6453 Trench 25b, mid ex  
6454 Trench 25b, mid ex  
6455 Trench 27, looking south  
6456 Trench 27, looking north  
6457 Trench 12, the second wall C.1211, looking south  
6459 Trench 12, the second wall C.1211, looking north  
6460 Trench 12, north facing section  
6461 Trench 12, south end of trench, west facing section  
6462 Trench 10, box trench with bedrock below natural in southern part of trench, looking south  
6463 Trench 10, box trench with bedrock below natural in southern part of trench, looking south  
6464 Trench 10, plan view of ditch in southern part of box trench, showing bedrock below natural bottom of cut  
6465 Trench 10, plan view of ditch in southern part of box trench, showing bedrock below natural bottom of cut  
6466 Close up of the feature described above  
6467 North facing section of trench 10 with ranging rods  
6468 West facing section of trench 10 without ranging rods  
6469 West facing section of trench 10 without ranging rods  
6470 South facing section of trench 10 with ranging rods  
6471 South facing section of trench 10 without ranging rods  
6472 Trench 25a following removal of rubble C.2503, looking north  
6473 Trench 25a, after removal of rubble C.2503, looking north

6474 Trench 25a, after removal of rubble C.2503, looking east  
6475 Trench 25a, after removal of rubble C.2503, looking south  
6476 Trench 25a, cobbled surface outside of house, looking south  
6477 Trench 25a, cobbled surface outside of house, looking south  
6478 Trench 25a, C.2505 on top of C.2506, looking south  
6479 Trench 25a, C.2505 on top of C.2506, looking south  
6480 Trench 25a, C.2505 on top of C.2506, looking south  
6481 Trench 12, post-ex, looking south  
6482 Trench 12, post-ex, looking north  
6483 East facing section of trench 12  
6484 East facing section of trench 12  
6485 West facing section of trench 12  
6486 West facing section of trench 12  
6487 South facing section of trench 10, C.1001, C.1010, C.1005  
6488 West facing section of trench 10  
6489 Northern part of west facing section of trench 10, shows very gentle slope  
6490 Southern part of west facing section of trench 10, shows the ditch (has a shadow)  
6491 East facing section of trench 10 (southern part), includes slate collapse  
6492 East facing section of trench 10 (northern part)  
6493 North facing section of trench 10 (left half of box trench)  
6494 Trench 27, south half desodded, looking south  
6495 Trench 27, showing stone surface, looking south  
6496 Trench 27, showing stone surface, looking north  
6497 Trench 27, south half of trench, looking north  
6498 Trench 25b, following removal of topsoil, looking west  
6499 Trench 25b, following removal of topsoil, looking east  
6500 Trench 25b, following removal of topsoil, looking north  
6501 Trench 25a, following removal of C.2504, showing possible floor level C.2508, looking north  
6502 Trench 25a, following removal of C.2504, showing possible floor level C.2508, looking north  
6503 Trench 25a, following removal of C.2504, showing possible floor level C.2508, looking north  
6504 Trench 25a, following removal of C.2504, showing possible floor level C.2508, looking north  
6505 Trench 25a, following removal of C.2504, showing possible floor level C.2508, looking east  
6506 Trench 25a, following removal of C.2504, showing possible floor level C.2508, looking south-east  
6507 Trench 25a, following removal of C.2504, showing possible floor level C.2508, looking south  
6508 Trench 25a, following removal of C.2504, showing possible floor level C.2508, looking south  
6509 Trench 25a, cobbles C.2506, outside house, looking south  
6510 Trench 25a, stone with hole, in-situ, looking north  
6511 North facing section of trench 17  
6512 North facing section of trench 18  
6513 Trench 25a, C.2513, possible feature in north-east corner of house, looking north  
6514 Trench 25a, C.2513, possible feature in north-east corner of house, looking north  
6515 Trench 25a, C.2513 from above the north-east corner of the house  
6516 Trench 25a, C.2513, north-east corner of house, looking north  
6517 Trench 25a, C.2513, north-east corner of house, looking north  
6518 Trench 25b, after removal of some of C.2511, looking west  
6519 Trench 25b, after removal of some of C.2511, looking north  
6520 Trench 25b, after removal of some of C.2511, looking east  
6521 Trench 25b, after removal of some of C.2511, looking south  
6522 Trench 25b, after removal of some of C.2511, looking south  
6523 Trench 25b, after removal of some of C.2511, looking south  
6524 Trench 25b, after removal of some of C.2511, looking east  
6525 Trench 25a, surface of C.2508, looking north  
6526 Trench 25a, surface of C.2508, looking north  
6527 Trench 25a, surface of C.2508, looking north-east  
6528 Trench 25a, surface of C.2508, looking north-east  
6529 Trench 25 a, surface of C.2508, wall C.2502, cobbles C.2506, looking south  
6530 Trench 25 a, surface of C.2508, wall C.2502, cobbles C.2506, looking south  
6531 Trench 25a, surface of C.2508, looking north  
6532 Trench 25a, surface of C.2508, looking north  
6533 Trench 25a, north-eastern corner of building C.2502, looking west  
6534 Trench 25a, wall C.2502, cobbles C.2506, looking south  
6535 Trench 25a, wall C.2502, cobbles C.2506, looking west

6536 Trench 25a, north-eastern corner of wall C.2502, showing location of missing keystone, looking west  
6537 Trench 28, removal of topsoil, looking east  
6538 Trench 28, removal of topsoil, looking south  
6539 Trench 28, removal of topsoil, looking west  
6540 Trench 28, removal of topsoil, looking north  
6541 Trench 28, close up of western half, looking north  
6542 Trench 28, close up of eastern half, looking north  
6543 Trench 26b, topsoil, looking west  
6544 Trench 26b, topsoil, looking west  
6545 Trench 26a, removal of sod, looking south  
6546 Trench 26a, removal of sod, looking south  
6547 Trench 28, post-ex, looking east  
6548 Trench 28, post-ex, looking south  
6549 Trench 28, post-ex, looking north  
6550 Trench 28, post-ex, looking west  
6551 Trench 25b, burnt area within C.2514, looking south  
6552 Trench 25b, burnt area within C.2514, looking south  
6553 Trench 25b, burnt area within C.2514, looking south  
6554 Trench 25b, burnt area within C.2514, looking south  
6555 Trench 25b, burnt area within C.2514, looking east  
6556 Trench 25b, burnt area within C.2514, looking east  
6557 Trench 28, post-ex, looking south  
6558 Trench 28, post-ex, looking south  
6559 Trench 28, post-ex, looking east  
6560 Trench 28, post-ex, looking west  
6561 Trench 28, post-ex, looking north  
6562 Trench 28, C.2806, possible drain, looking east  
6563 Trench 28, C.2806, possible drain, looking south  
6564 Trench 28, uncovered wood  
6565 Trench 25c, after removal of sod, looking north  
6566 Trench 25c, after removal of sod, looking south  
6567 Trench 26a, mid-ex, C.2601 topsoil, C.2602 stones, looking south  
6568 Trench 26a, mid-ex, C.2601 topsoil, C.2602 stones, looking south  
6569 Trench 26a, mid-ex, C.2601 topsoil, C.2602 stones, looking east  
6570 Trench 26a, mid-ex, C.2601 topsoil, C.2602 stones, looking east  
6571 Trench 25a, surface of C.2508, C.2502, looking north  
6572 Trench 25a, surface of C.2508, C.2502, looking north  
6573 Trench 25a, surface of C.2508, C.2502, looking north  
6574 Trench 25a, surface of C.2508, C.2502, looking north  
6575 Trench 25a, surface of C.2508, C.2502, looking north  
6576 Trench 25a, surface of C.2508, C.2502, looking north-east  
6577 Trench 25a, surface of C.2508, C.2502, looking north-east  
6578 Trench 26b, following removal of C.2601, looking west  
6579 Trench 26b, following removal of C.2601, looking west  
6580 Trench 26b, following removal of C.2601, looking west  
6581 Trench 25a, detailed photos of building  
6582 Trench 25a, detailed photos of building  
6583 Trench 25a, detailed photos of building  
6584 Trench 25a, detailed photos of building  
6585 Trench 25a, detailed photos of building  
6586 Trench 25a, detailed photos of building  
6587 Trench 25a, detailed photos of building  
6588 Trench 25a, detailed photos of building  
6589 Trench 25a, detailed photos of building  
6590 Trench 25a, pivot stone  
6597 Trench 26a, mid-ex of C.2601, looking south  
6598 Trench 26a, mid-ex of C.2601, looking south  
6599 Trench 26a, mid-ex of C.2601, looking east  
6600 Trench 26a, mid-ex of C.2601, looking east  
6601 Trench 26b, following removal of C.2601, looking west  
6602 Trench 26b, following removal of C.2601, looking west  
6603 Trench 26b, following removal of C.2601, looking west



6604 Trench 26b, following removal of C.2601, looking south  
6605 Trench 26b, following removal of C.2601, looking south  
6606 Surface of C.2508 and C.2502 (wall), looking north  
6607 Surface of C.2508 and C.2502 (wall), looking north  
6608 Surface of C.2508 and C.2502 (wall), looking north  
6609 Surface of C.2508 and C.2502 (wall), looking north  
6610 Trench 25b, mid-ex, looking south  
6611 Trench 25b, mid-ex, looking south  
6612 Trench 25b, mid-ex, looking north  
6613 Trench 25b, mid-ex, looking north  
6614 Trench 25b, mid-ex, looking east  
6615 Trench 25b, mid-ex, looking east  
6616 Trench 25b, mid-ex, looking west  
6617 Trench 25b, mid-ex, looking west  
6618 Trench 25b, mid-ex, looking west  
6619 Trench 25b, burnt area south-east of trench, looking west  
6620 Trench 25b, burnt area south-east of trench, looking south  
6621 Trench 25b, burnt area south-east of trench, looking south  
6622 Trench 28, post-ex, looking east  
6623 Trench 28, post-ex, looking north  
6624 Trench 28, post-ex, looking west  
6625 Trench 28, post-ex, looking south  
6626 Trench 28, post-ex, looking south  
6627 Trench 28, post-ex, wood feature, north-east corner  
6628 Trench 28, C.2806 (suspected drain), looking south  
6629 Trench 28, C.2806 (suspected drain), looking east  
6630 Trench 21, following removal of sod layer, looking east  
6631 Trench 21, following removal of sod layer, looking south  
6632 Trench 21, following removal of sod layer, looking west  
6633 Trench 21, following removal of sod layer, looking north  
6634 Trench 27, post-ex plan, looking south  
6635 Trench 27, post-ex plan, looking south  
6636 Trench 27, post-ex, southern third, looking south  
6637 Trench 27, post-ex, looking north  
6638 Trench 27, post-ex, looking north  
6639 Trench 27, southern third, east facing section  
6640 Trench 27, east facing section  
6641 Trench 27, east facing section  
6642 Trench 27, east facing section  
6643 Trench 27, subsoil cut feature, south of trench  
6644 Trench 27, subsoil cut feature, south of trench  
6645 Trench 27, subsoil cut feature, south of trench  
6646 Trench 27, subsoil cut feature, south of trench  
6647 Surface of C.2508 and C.2502 (wall), looking north  
6648 Surface of C.2508 and C.2502 (wall), looking north  
6649 Surface of C.2508, looking east  
6650 Surface of C.2508, looking east  
6651 Surface of C.2508 and C.2502 (wall), looking north-east  
6652 Trench 25b, C.2527, looking west  
6653 Trench 25b, C.2527, looking east  
6654 Trench 25b, C.2527, looking west  
6655 Trench 25c, post-ex, looking south  
6656 Trench 25c, west facing profile of wall  
6657 Trench 25c, post-ex, looking north  
6658 Trench 26a, surfaces C.2604, C.2605, C.2606, looking south  
6659 Trench 26a, surfaces C.2604, C.2605, C.2606, looking south  
6660 Trench 26a, surfaces C.2604, C.2605, C.2606, looking east  
6661 Trench 26a, surfaces C.2604, C.2605, C.2606, looking east  
6662 Trench 28, box section through C.2805, facing north  
6663 Trench 28, box section through C.2805, facing north  
6664 Trench 28, box section through C.2805, facing south  
6665 Trench 28, box section through C.2805, facing south

6666 Trench 26a, surface of C.2604, looking north  
6667 Trench 26a, surface of C.2604, looking north  
6668 Trench 26a, surface of C.2604, in plan  
6669 Trench 26a, surface of C.2604, in plan  
6670 Trench 25a, surface of C.2508 and C.2502 (wall), looking north  
6671 Trench 25a, surface of C.2508 and C.2502 (wall), looking north  
6672 Trench 25a, surface of C.2508 and C.2502 (wall), looking north  
6673 Trench 25a, surface of C.2508 and C.2502 (wall), looking north  
6674 Trench 25a, surface of C.2508 and C.2502 (wall), looking north-east  
6675 Trench 25a, surface of C.2508 and C.2502 (wall), looking north-east  
6676 Trench 25a, surface of C.2508, looking west  
6677 Trench 25a, surface of C.2508, looking west  
6678 Trench 25a, surface of C.2508, looking west  
6679 Trench 25a, surface of C.2508, looking west  
6680 Trench 25a, surface of C.2508, looking west  
6681 Trench 25a, surface of C.2508, looking west  
6682 Trench 25a, surface of C.2508, looking west  
6683 Trench 25a, surface of C.2508 and C.2502 (wall), looking north-east  
6684 Trench 25a, surface of C.2508 and C.2502 (wall), looking north-east  
6685 Trench 25a, surface of C.2508 and C.2502 (wall), looking north-east  
6686 Trench 25a, surface of C.2508 and C.2502 (wall), looking north-east  
6687 Trench 25a, surface of C.2508, C.2506 and C.2502, looking south  
6688 Trench 25a, surface of C.2508, C.2506 and C.2502, looking south  
6689 Trench 25a, surface of C.2508, C.2506 and C.2502, looking south-east  
6690 Trench 25a, surface of C.2508, C.2506 and C.2502, looking south-east  
6691 Trench 25a, surface of C.2508, C.2506 and C.2502, looking south  
6692 Trench 25a, C.2506 (cobble) and eastern section of C.2502 (wall) with missing keystone, looking south  
6693 Possible feature after removal of C.2513, looking east  
6694 Possible feature after removal of C.2513, looking east  
6695 Possible feature after removal of C.2513, looking north  
6696 Possible feature after removal of C.2513, looking north  
6697 Possible feature containing C.2513, from above  
6698 Possible feature containing C.2513, from above  
6701 Trench 25a, surface C.2508, from above  
6702 Trench 25a, surface C.2508, from above  
6703 Trench 25a, surface C.2508, from above  
6704 Trench 25a, surface C.2508 and wall C.2502, from above  
6705 Trench 25a, eastern wall C.2502 and cobbles C.2506, from above  
6707 Trench 25a, surface C.2508, wall C.2502 and cobbles C.2506, from above  
6708 Trench 25a, surface C.2508, wall C.2502 and cobbles C.2506, from above  
6709 Trench 25a, surface C.2508, wall C.2502 and cobbles C.2506, from above  
6711 Trench 25a, surface C.2508, wall C.2502 and cobbles C.2506, from above  
6712 Trench 25a, surface C.2508, wall C.2502 and cobbles C.2506, from above  
6713 Trench 25a, surface C.2508, wall C.2502 and cobbles C.2506, from above  
6714 Trench 25a, surface C.2508, wall C.2502 and cobbles C.2506, from above  
6715 Trench with Laura  
6716 Trench 25a, surface C.2508, wall C.2502 and cobbles C.2506, from above  
6717 Trench 25a, north facing section  
6718 Trench 25a, west facing section  
6719 Trench 25a, west facing section  
6720 Trench 21, post-ex after removal of topsoil, looking north  
6721 Trench 21, post-ex after removal of topsoil, looking east  
6722 Trench 21, post-ex after removal of topsoil, looking south  
6723 Trench 21, post-ex after removal of topsoil, looking west  
6724 Trench 21, post-ex, close-up of path feature, looking south  
6725 Trench 21, post-ex, close-up of path feature, looking south  
6726 Trench 25a, wall 2539  
6727 Trench 25a, wall 2539  
6728 Trench 23b, pre-ex, looking west  
6729 Trench 23b, pre-ex, looking east  
6730 Trench 26a, post-ex of C.2606, looking south  
6731 Trench 26a, post-ex of C.2606, looking south

6732 Trench 26a, post-ex of C.2606, looking east  
6733 Trench 26a, post-ex of C.2606, looking east  
6734 Trench 26a, south facing section  
6735 Trench 26a, south facing section  
6736 Trench 26a, west facing section  
6737 Trench 26a, west facing section  
6738 Trench 26a, west facing section  
6739 Trench 26a, west facing section  
6740 Trench 26a, north facing section  
6741 Trench 26a, north facing section  
6742 Trench 29, post-ex  
6743 Trench 29, west facing section  
6744 Trench 26b, showing wall, looking west  
6745 Trench 26b, showing wall, looking west  
6746 Trench 26b, showing wall, looking south  
6747 Trench 26b, showing wall, looking south  
6828 Trench 22b, C.2202, C.2203 and C.2204, looking west  
6829 Trench 22b, C.2202, C.2203 and C.2204, looking east  
6830 Trench 22b, C.2202, looking north-west  
6831 Trench 22a, after removal of topsoil showing C.2205, looking north  
6832 Trench 22a, after removal of topsoil showing C.2205, looking south  
6833 Trench 11, after removal of topsoil  
6834 Trench 26b, west facing overall plan showing C.2611  
6835 Trench 26b, west facing plan of southern part showing C.2611  
6836 Trench 26b, west facing C.2611  
6837 Trench 26b, south facing C.2611 and including section  
6838 Trench 26b, south facing of C.2611  
6839 Trench 25a, wall C.2502 and external area, looking south  
6840 Trench 25a, wall C.2502, looking west  
6841 Trench 25a, wall C.2502 and external area, looking south  
6842 Trench 25a, wall C.2502 and external area, looking south  
6843 Trench 25a, C.2508, C.2502 and external are, looking north  
6844 Trench 25a, C.2508, C.2502 and external are, looking north  
6845 Trench 22a, mid-ex after removal of C.2205, looking north  
6846 Trench 22a, mid-ex after removal of C.2205, looking south  
6847 Trench 25b, post-ex, looking west  
6848 Trench 25b, post-ex, looking south  
6849 Trench 25b, post-ex, looking east  
6850 Trench 25b, post-ex, looking east  
6851 Trench 25b, post-ex, looking west  
6852 Trench 25b, post-ex, looking west  
6853 Trench 25b, post-ex, looking west  
6854 Trench 25b, post-ex, looking west  
6855 Trench 25b, metalled surface C.2525, looking north  
6856 Trench 25b, metalled surface C.2525, looking north  
6857 Trench 26b, following removal of C.2611, looking west  
6858 Trench 26b, following removal of C.2611, looking west  
6859 Trench 26b, following removal of C.2611, looking south  
6860 Trench 26b, following removal of C.2611, looking west  
6861 Trench 26b, following removal of C.2611, looking west  
6862 Trench 26b, following removal of C.2611, looking south  
6863 Trench 11, mid-ex linear gully west side  
6864 Trench 11, mid-ex linear gully west side  
6865 Trench 22a, looking north  
6866 Trench 22a, looking south  
6867 Trench 22a, east facing section - northern half, looking west  
6868 Trench 22a, east facing section - southern half, looking west  
6869 Trench 22a, west facing section - southern half, looking east  
6870 Trench 22a, west facing section - northern half, looking east  
6871 Trench 22b, following removal of C.2203, looking west  
6872 Trench 22b, following removal of C.2203, looking east  
6873 Trench 22b, following removal of C.2203, looking east

6874 Trench 11, north facing section  
6875 Trench 11, post-ex of cut C.1104  
6876 Trench 11, post-ex, looking west  
6877 Trench 26b, following removal of C.2612, looking west  
6878 Trench 26b, following removal of C.2612, looking west  
6879 Trench 26b, following removal of C.2612, looking south  
6880 Trench 26b, following removal of C.2612, looking south  
6881 Trench 26b, following removal of C.2612, looking south  
6882 Trench 26b, following removal of C.2612, looking south  
6883 Trench 26b, detail of thresholds, looking south  
6884 Trench 26b, detail of thresholds, looking south  
6890 Trench 22c, following removal of topsoil, looking west  
6891 Trench 22c, following removal of topsoil, looking east  
6892 Trench 22a, mid-ex, looking south  
6893 Trench 22a, mid-ex, looking north  
6894 Trench 22a, mid-ex, looking north  
6895 Trench 22a, mid-ex, east facing section, looking west  
6896 Trench 22a, mid-ex, east facing section, looking west  
6897 Trench 22a, mid-ex - southern third, looking west  
6898 Trench 22a, mid-ex - middle third, looking west  
6899 Trench 22a, mid-ex - northern third, looking west  
6900 Trench 28, mid-ex, looking west  
6901 Trench 28, mid-ex, looking east  
6902 Trench 22b, mid-ex metalled surface, looking east  
6903 Trench 22b, mid-ex metalled surface, looking west  
6904 Trench 22b, mid-ex metalled surface, looking east  
6905 Trench 22b, mid-ex metalled surface, looking west  
6906 Trench 22b, mid-ex metalled surface, looking east  
6907 Trench 22b, mid-ex metalled surface, looking east  
6908 Trench 22b, mid-ex metalled surface, looking west  
6909 Trench 22b, mid-ex metalled surface, looking south  
6910 Trench 22b, mid-ex metalled surface, looking east  
6911 Trench 26b, working shot  
6912 Trench 26b, working shot  
6913 Trench 26b, working shot  
6914 Trench 22c, following removal of topsoil, looking west  
6915 Trench 22c, following removal of topsoil, looking east  
6916 Trench 26b, C.2615 and partial removal of C. 2614, looking west  
6917 Trench 26b, C.2615 and partial removal of C. 2614, looking west  
6918 Trench 26b, C.2615 and partial removal of C. 2614, looking south  
6919 Trench 26b, C.2615 and partial removal of C. 2614, looking south  
6920 Trench 28, looking north  
6921 Trench 22a, mid-ex C.2213, looking north  
6922 Trench 22a, mid-ex C.2213, looking south  
6930 Trench 28, post-ex, looking west  
6931 Trench 28, north facing section  
6932 Trench 28, north facing section  
6933 Trench 28, north facing section  
6934 Trench 28, north facing section  
6935 Trench 28, north facing section  
6936 Trench 28, post-ex, looking east  
6937 Trench 26b, post-ex, looking west  
6938 Trench 26b, post-ex, looking west  
6939 Trench 26b, post-ex, looking south  
6940 Trench 26b, post-ex, looking south  
6941 Trench 26b, wall (C.2608), looking west  
6942 Trench 26b, wall (C.2608), looking west  
6943 Trench 26b, wall (C.2608), looking south  
6944 Trench 26b, wall (C.2608), looking south  
6945 Trench 26b, plan showing detail of threshold  
6946 Trench 26b, plan showing detail of threshold  
6947 Trench 26b, plan showing beaten clay surface C.2616

6948 Trench 26b, plan showing beaten clay surface C.2616  
 6949 Trench 26b, plan showing possible hearth C.2617  
 6950 Trench 26b, plan showing possible hearth C.2617  
 6951 Trench 22a  
 6952 Trench 22a  
 6953 Trench 22a  
 6954 Trench 22b, sondage through C.2211, looking east  
 6955 Trench 22b, sondage through C.2211, looking east  
 6956 Trench 22b, sondage through C.2211, looking north  
 6957 Trench 22b, sondage through C.2211, looking west  
 6958 Trench 26b, post-ex, looking north-east  
 6959 Trench 26b, post-ex, looking south-east  
 6960 Trench 26b, post-ex, looking north  
 6961 Trench 26b, post-ex, looking north-east  
 6962 Trench 26b, post-ex, looking north-east  
 6963 Trench 26b, post-ex, looking north  
 6964 Trench 26b, post-ex, looking north-west  
 6965 Trench 22c, post-ex, looking west  
 6966 Trench 22c, post-ex, looking east  
 6969 Trench 30c, post-ex C.3002, looking north  
 6970 Trench 30c, post-ex C.3002, looking north  
 6971 Trench 30c, post-ex C.3002, looking east  
 6972 Trench 30c, post-ex C.3002, looking east  
 6973 Trench 30c, post-ex C.3002, looking south  
 6974 Trench 30c, post-ex C.3002, looking south  
 6975 Trench 30c, post-ex C.3002, looking west  
 6976 Trench 30c, post-ex C.3002, looking west  
 6977 Trench 22a, post-ex, looking north  
 6978 Trench 22a, post-ex, looking south  
 6979 Trench 22a, post-ex northern half, looking east  
 6980 Trench 22a, post-ex southern half, looking east  
 6981 Trench 22a, post-ex northern half, looking west  
 6982 Trench 22a, post-ex southern half, looking west  
 6983 Trench 22a, post-ex southern half, looking north  
 6984 Trench 22a, post-ex southern half, looking north  
 6985 Trench 22a, post-ex northern half, looking south  
 6986 Trench 22b, post-ex, looking east  
 6987 Trench 22b, post-ex east half, looking north  
 6988 Trench 22b, post-ex east half, looking west  
 6994 Trench 30d, post-ex exposed stones  
 6995 Trench 30d, post-ex exposed stones  
 6996 Trench 11, two gullies, looking east  
 6997 Trench 11, two gullies, looking south  
 6998 Trench 30b, post-ex showing cobbles, looking north  
 6999 Trench 30b, post-ex showing cobbles, looking east  
 7000 Trench 30b, post-ex showing cobbles, looking south  
 7001 Trench 30b, post-ex showing cobbles, looking west  
 7002 Trench 30b, post-ex showing cobbles, looking north  
 7003 Trench 11, post-ex, looking east  
 7004 Trench 11 extension, north facing section  
 7005 Trench 11 extension, north facing section  
 7006 Trench 11 extension, post-ex  
 7010 Trench 30e, post-ex  
 7017 Possible medieval pottery  
 7019 Possible medieval pottery  
 7022 Trench 25a, post-ex, looking east  
 7023 Trench 25a, post-ex, looking south-east  
 7024 Trench 25a, post-ex, looking north  
 7025 Trench 25a, post-ex, looking north  
 7026 Trench 25a, post-ex, looking north-east  
 7027 Trench 25a, road and N-S wall, looking south  
 7028 Trench 25a, road and N-S wall, looking south

7029 Trench 25a, road and E-W wall, looking west  
7030 Trench 25a, road and E-W wall, looking west  
7031 Trench 25a, blocked-up door and clay floor, looking west  
7032 Trench 25a, interior floor, looking north  
7033 Trench 25a, post-ex, looking north  
7034 Trench 25a, post-ex, looking north  
7035 Trench 25a, interior of building, looking east  
7036 Trench 25a, post-ex, looking north-east  
7037 Trench 25a, post-ex, looking north-east  
7038 Trench 25a, blocked-up doorway, looking east  
7039 Trench 25a, blocked-up doorway, looking east  
7040 Trench 25a, blocked-up doorway, looking east  
7041 Trench 25a, blocked-up doorway, looking east  
7042 Trench 25a, blocked-up doorway, looking east  
7043 Trench 25a, metalled surface from above  
7044 Trench 25a, metalled surface from above  
7045 Trench 25a, blocked-up doorway, looking west  
7046 Trench 25a, elevation of north-east corner, looking west  
7047 Trench 25a, edge of roadway, looking north  
7048 Trench 21, post-ex slot trench north-west corner of trench, looking south  
7049 Trench 21, post-ex slot trench north-west corner of trench, looking west  
7050 Trench 21, post-ex slot trench north-west corner of trench, looking north  
7051 Trench 17, post-ex, looking east  
7052 Trench 17, post-ex, looking north  
7053 Trench 17, post-ex, looking north  
7054 Trench 17, post-ex, looking east  
7055 Trench 17, post-ex, looking east  
7056 Trench 17, blocked up door, looking east  
7057 Trench 17, blocked up door, looking east  
7058 Trench 17, post-ex, looking north-east  
7059 Trench 17, post-ex gully feature, from above  
7060 Trench 17, post-ex gully feature, from above  
7061 Trench 30f, post-ex metalled surface, from above  
7062 Trench 30f, post-ex metalled surface, from above  
7063 Trench 30f, post-ex metalled surface, looking south  
7064 Trench 30f, post-ex metalled surface, looking east  
7065 Trench 30f, post-ex metalled surface, looking west  
7066 Trench 30f, post-ex metalled surface, looking north  
7067 Trench 25a, post-ex, from above  
7068 Trench 31, after removal of sod and topsoil, looking west  
7069 Trench 31, after removal of sod and topsoil, looking east  
7070 Trench 30g, post-ex  
7071 Trench 30g, post-ex  
7072 Trench 32, after removal of sod, looking north  
7073 Trench 32, after removal of sod, looking south  
7074 Trench 31, C.3102 stone and gravel layer, looking east  
7075 Trench 31, C.3102 stone and gravel layer, looking west  
7076 Trench 30h, working shot  
7077 Trench 30h, working shot  
7078 Trench 30h, working shot  
7079 Trench 31, working shot  
7080 Trench 31, working shot  
7081 Trench 31, working shot  
7082 Trench 30h, C.3011 and bedrock, looking west  
7083 Trench 30h, C.3011 and bedrock, looking west  
7084 Trench 30h, C.3011 and bedrock, looking west  
7085 Trench 30h, C.3011 and bedrock, looking south  
7086 Trench 30h, C.3011 and bedrock, looking south  
7087 Trench 30h, C.3011 and bedrock, looking north  
7088 Trench 30h, C.3011 and bedrock, looking east  
7089 Trench 30h, C.3011 and bedrock, looking east  
7090 Trench 30h, C.3011 and bedrock, looking east

7091 Trench 31, after removal of C3102, looking east  
7092 Trench 31, after removal of C3102, looking east  
7093 Trench 31, after removal of C3102, looking west  
7094 Trench 31, after removal of C3102, looking west  
7095 Trench 31, after removal of C3102, eastern third, looking south  
7096 Trench 31, after removal of C3102, middle third, looking south  
7097 Trench 31, after removal of C3102, western third, looking south  
7107 Trench 13a and 13b, aerial shot  
7108 Trench 13a and 13b, aerial shot  
7109 Trench 13a and 13b, aerial shot  
7110 Trench 13a and 13b, aerial shot  
7111 Trench 13a and 13b, aerial shot  
7112 Trench 13a and 13b, aerial shot  
7113 Trench 13a and 13b, aerial shot  
7114 Trench 13a and 13b, aerial shot  
7115 Trench 13a and 13b, aerial shot  
7116 Trench 13a and 13b, aerial shot  
7117 Trench 10, east facing section  
7118 Trench 10, east facing section  
7119 Trench 10, east facing section  
7120 Trench 10, east facing section  
7121 Trench 10, east facing section  
7122 Trench 13a and 13b, aerial shot  
7123 Trench 13a and 13b, aerial shot  
7124 Trench 13a and 13b, aerial shot  
7125 Trench 13a and 13b, aerial shot  
7126 Trench 13a and 13b, aerial shot  
7127 Trench 13a and 13b, aerial shot  
7128 Trench 13a and 13b, aerial shot  
7129 Trench 13a and 13b, aerial shot  
7130 Trench 13a and 13b, aerial shot  
7131 Trench 13b, wall  
7132 Trench 13a, wall running N-S  
7133 Trench 13a, corner of structure, looking south  
7134 Trench 13a, corner of structure, from above  
7135 Trench 13a, corner of structure, looking west  
7136 Trench 13a, corner of structure, looking west  
7140 Trench 10, west facing section  
7141 Trench 10, west facing section  
7142 Trench 9b, looking north  
7143 Trench 9b, looking west  
7144 Trench 9b, west facing elevation of C.903  
7145 Trench 9b, north facing elevation of C.903  
7147 Trench 9b, south facing elevation of C.905  
7148 Trench 9b, north facing elevation of C.905  
7150 Trench 9b, south facing elevation of C.903  
7151 Trench 9b, south facing elevation of C.903  
7152 Trench 9b, south facing elevation of C.903  
7153 Trench 9b, north facing elevation of C.903  
7154 Trench 9b, south facing elevation of C.905  
7155 Trench 9b, north facing elevation of C.905  
7156 Trench 9b, west facing elevation of C.928  
7157 Trench 9b, east facing elevation of C.928  
7158 Trench 9b, east facing elevation of C.928  
7159 Trench 31, western half of south facing section  
7160 Trench 31, eastern half of south facing section  
7161 Trench 31, looking west  
7162 Trench 31, looking east  
7163 Trench 31, looking east  
7164 Trench 9a and 9b, aerial shot  
7165 Trench 9a and 9b, aerial shot  
7166 Trench 9a and 9b, aerial shot

7167 Trench 9a and 9b, aerial shot  
7168 Trench 9a and 9b, aerial shot  
7169 Trench 9a and 9b, aerial shot  
7170 Trench 9a and 9b, aerial shot  
7171 Trench 9a and 9b, aerial shot  
7172 Trench 9b, aerial shot  
7173 Trench 9b, aerial shot  
7174 Trench 9a and 9b, aerial shot  
7175 Trench 9a and 9b, aerial shot  
7176 Trench 9a and 9b, aerial shot  
7177 Trench 9a and 9b, aerial shot  
7178 Trench 9a and 9b, aerial shot  
7179 Trench 9a and 9b, aerial shot  
7180 Trench 9a and 9b, aerial shot  
7181 Trench 9a and 9b, aerial shot  
7183 Trench 23b, aerial shot  
7184 Trench 23a, aerial shot  
7185 Trench 23a, aerial shot  
7186 Trench 23a, aerial shot  
7187 Trench 23a, aerial shot  
7188 Trench 23a, aerial shot  
7189 Trench 23a, aerial shot  
7190 Trench 23a and 23b, aerial shot  
7191 Trench 23a and 23b, aerial shot  
7192 Trench 23a  
7193 Working shot  
7194 Trench 16, aerial shot  
7195 Trench 16, aerial shot  
7196 Trench 16, east facing section  
7197 Trench 16, east facing section  
7198 Trench 16, aerial shot, looking north  
7199 Trench 16, aerial shot, looking north  
7200 Trench 25a, aerial shot  
7201 Trench 25a, aerial shot  
7202 Trench 25a, aerial shot  
7203 Trench 25a, aerial shot  
7204 Trench 25a, aerial shot  
7205 Trench 25a, aerial shot  
7206 Trench 25a, aerial shot, looking north  
7207 Trench 25a, aerial shot  
7208 Trench 25a, aerial shot  
7209 Trench 25a, aerial shot  
7210 Working shot  
7211 Working shot  
7212 Wall being repointed  
7213 Wall being repointed  
7214 Working shot  
7215 Working shot  
7216 Working shot  
7217 Working shot  
7218 Working shot  
7219 Working shot  
7220 Working shot  
7221 Working shot  
7222 Working shot  
7223 Working shot  
7224 Working shot  
7225 Working shot  
7226 Working shot  
7227 Working shot  
7235 Working shot  
7236 Working shot



7239 Working shot  
7246 Working shot  
7247 Working shot  
7259 Working shot  
7260 Working shot  
7261 Working shot  
7262 Working shot  
7263 Working shot  
7264 Working shot  
7265 Working shot  
7270 Trench 26b, aerial shot  
7271 Trench 26b, aerial shot  
7272 Trench 26b, aerial shot  
7273 Trench 26b, aerial shot  
7274 Trench 26b, aerial shot  
7275 Trench 26b, aerial shot  
7276 Trench 26b, aerial shot  
7277 Trench 26b, aerial shot  
7278 Trench 26b, aerial shot  
7279 Trench 26b, aerial shot  
7280 Trench 26b, aerial shot  
7284 Trench 22a, east facing section, southern half  
7285 Trench 22a, east facing section, southern half  
7286 Trench 22a, east facing section, northern half  
7287 Trench 22a, east facing section, northern half  
7288 Trench 22a, east facing section  
7289 Trench 22a, post-ex, looking north  
7290 Trench 22a, post-ex, looking south  
7291 Trench 22a, cut and post-hole feature, looking south  
7292 Trench 22a, west facing section, northern half  
7293 Trench 22a, west facing section, southern half  
7294 Trench 22a, west facing section, northern half  
7295 Trench 30d, post-ex, looking east  
7296 Trench 30d, post-ex, looking north  
7297 Trench 30d, post-ex, looking west  
7298 Trench 30h, mid-ex with extension, looking north  
7299 Trench 30h, mid-ex with extension, looking north  
7300 Trench 30h, northern area top of bank, looking west  
7301 Trench 30h, northern area top of bank, looking west  
7302 Trench 30h, showing incline of bank, looking west  
7303 Trench 30h, showing incline of bank, looking west  
7304 Trench 32, looking north  
7305 Trench 32, looking south  
7306 Trench 32, northern half, looking east  
7307 Trench 32, southern half, looking east  
7308 Trench 32, southern half, looking west  
7309 Trench 32, northern half, looking west  
7311 Trench 28, looking east  
7312 Trench 28, looking east  
7313 Trench 28, looking east  
7314 Trench 28, looking east  
7315 Trench 28, looking east  
7316 Trench 28, looking east  
7317 Trench 28, looking east  
7318 Trench 28, looking east  
7319 Trench 28, looking east  
7320 Trench 28, cobbles, looking north  
7321 Trench 28, extended area, looking east  
7322 Trench 28, extended area, looking east  
7323 Trench 28, looking west  
7324 Trench 28, looking west  
7325 Trench 28, looking west

7326 Trench 32, post-ex, looking north  
7327 Trench 32, post-ex, looking north  
7328 Trench 32, post-ex, looking south  
7329 Trench 32, post-ex, looking south  
7330 Trench 32, post-ex, looking west  
7331 Trench 32, extension post-ex, looking west  
7332 Trench 30h, post-ex, looking south  
7333 Trench 30h, post-ex, looking south  
7334 Trench 30h, post-ex, looking north  
7335 Trench 30h, post-ex, looking north  
7336 Trench 30h, post-ex, looking north  
7337 Trench 30h, post-ex, looking north  
7338 Trench 30h, rubble collapse, looking west  
7339 Trench 30h, top of bank, looking west  
7340 Trench 30h, showing incline, looking west  
7341 Trench 30h, northern extent, looking west

**APPENDIX 5: SAMPLE REGISTER**

| <b>Sample No.</b> | <b>Context No.</b> | <b>Trench</b> | <b>Area</b> | <b>No. of bags</b> | <b>Reason for sampling; sample type</b> | <b>Comments</b>                      |
|-------------------|--------------------|---------------|-------------|--------------------|---|--------------------------------------|
| 1                 | 1303               | 13            | G           | 2                  | Enviro. - Seeds, etc.                   | Processed for uncharred macrofossils |
| 2                 | 804                | 8             | G           | 3                  | Enviro. - Seeds, etc.                   | Processed for uncharred macrofossils |
| 3                 | 707                | 7             | G           | 4                  | Enviro - Seeds etc                      | Unprocessed                          |
| 4                 | 707                | 7             | G           | 2                  | Enviro - Seeds etc                      | Processed for uncharred macrofossils |
| 5                 | 1319               | 13            | G           | 2                  | Enviro. - Seeds, etc.                   | Processed for uncharred macrofossils |
| 6                 | 712                | 7             | G           | 1                  | Enviro. - Seeds, etc.                   | Unprocessed                          |
| 7                 | 714                | 7             | G           | 2                  | c14 dating                              | Processed, radiocarbon dated         |
| 8                 | 717                | 7             | G           | 3                  | Enviro. - Seeds, etc.                   | Unprocessed                          |
| 9                 | 2012               | 20            | T           | 1                  | Enviro. - Seeds, etc.                   | Unprocessed                          |
| 10                | 916                | 9b            | G           | 1                  | Enviro. - Seeds, etc.                   | Unprocessed                          |
| 11                | 917                | 9b            | G           | 2                  | Enviro. - Seeds, etc.                   | Unprocessed                          |
| 12                | 913                | 9b            | G           | 1                  | Enviro. - Seeds, etc.                   | Unprocessed                          |
| 13                | 2016               | 20            | T           | 1                  | Enviro. - Seeds, etc.                   | Unprocessed                          |
| 14                | 938                | 9a            | G           | 1                  | Enviro. - Seeds, etc.                   | Unprocessed                          |
| 15                | 937                | 9a            | G           | 1                  | Enviro. - Seeds, etc.                   | Unprocessed                          |
| 16                | 939                | 9a            | G           | 1                  | Enviro. - Seeds, etc.                   | Unprocessed                          |
| 17                | 2505               | 25a           | T           | 1                  | Enviro. - Seeds, etc.                   | Unprocessed                          |
| 18                | 2518               | 25b           | T           | 1                  | Enviro. - Seeds, etc.                   | Unprocessed                          |
| 19                | 2521               | 25b           | T           | 1                  | Enviro. - Burnt layer                   | Unprocessed                          |
| 20                | 2604               | 26a           | E           | 1                  | Enviro. - Burnt layer                   | Unprocessed                          |
| 21                | 2607               | 26a           | E           | 1                  | Enviro. - Burnt layer                   | Unprocessed                          |
| 22                | 2605               | 26a           | E           | 1                  | Enviro. - Seeds, etc.                   | Unprocessed                          |
| 23                | 2213               | 22a           | T           | 1                  | Enviro. - Seeds, etc.                   | Processed for uncharred macrofossils |
| 24                | 2222               | 22a           | T           | 1                  | c14 dating                              | Processed and radiocarbon dated      |
| 25                | 1611               | 16            | G           | 1                  | Enviro. - Seeds, etc.                   | Processed for charred macrofossils   |
| 26                | 931                | 9a            | G           | 2                  | Enviro. - Seeds, etc.                   | Unprocessed                          |
| 27                | 911                | 9b            | G           | 2                  | Enviro. - Seeds, etc.                   | Unprocessed                          |
| 28                | 1103               | 11            | G           | 2                  | Enviro. - Seeds, etc.                   | Unprocessed                          |
| 29                | Void               | Void          | Void        | Void               | Void                                    | Void                                 |

|    |      |     |   |   |                       |                                      |
|----|------|-----|---|---|-----------------------|--------------------------------------|
| 30 | 1110 | 11  | G | 2 | Enviro. - Seeds, etc. | Unprocessed                          |
| 31 | 1002 | 10  | G | 2 | Enviro. - Seeds, etc. | Unprocessed                          |
| 32 | 1004 | 10  | G | 2 | Enviro. - Seeds, etc. | Unprocessed                          |
| 33 | 1704 | 17  | G | 2 | Enviro. - Seeds, etc. | Processed for uncharred macrofossils |
| 34 | 2206 | 22a | T | 1 | Enviro. - Seeds, etc. | Unprocessed                          |
| 35 | 2316 | 23b | T | 1 | Mortar Sample         | Unprocessed                          |
| 36 | 2208 | 22a | T | 1 | Enviro. - Seeds, etc. | Unprocessed                          |
| 37 | 2209 | 22a | T | 1 | Enviro. - Seeds, etc. | Unprocessed                          |
| 38 | 2617 | 26b | E | 1 | c14 dating            | Processed and radiocarbon dated      |
| 39 | 1611 | 16  | G | 1 | c14 dating            | Processed and radiocarbon dated      |

## APPENDIX 6: FINDS REGISTER

### Small Finds

| Small find number | Area | Trench | Context | Type    |
|-------------------|------|--------|---------|---------|
| 342               | C    | 1      | 101     | Pottery |
| 343               | C    | 1      | 101     | Pottery |
| 344               | C    | 1      | 101     | Pottery |
| 345               | C    | 1      | 101     | Pottery |
| 346               | C    | 1      | 101     | Pottery |
| 347               | C    | 1      | 101     | Pottery |
| 348               | C    | 1      | 102     | Pottery |
| 349               | C    | 1      | 102     | Pottery |
| 350               | C    | 1      | 102     | Pottery |
| 351               | C    | 1      | 102     | Pottery |
| 352               | C    | 1      | 102     | Pottery |
| 353               | C    | 1      | 102     | Pottery |
| 354               | C    | 1      | 102     | Pottery |
| 355               | C    | 1      | 102     | Pottery |
| 356               | C    | 1      | 102     | Pottery |
| 357               | C    | 1      | 102     | Pottery |
| 358               | C    | 1      | 102     | Pottery |
| 359               | C    | 1      | 102     | Pottery |
| 360               | C    | 1      | 102     | Pottery |
| 361               | C    | 1      | 102     | Pottery |
| 362               | C    | 1      | 102     | Pottery |
| 363               | C    | 1      | 102     | Pottery |
| 364               | C    | 1      | 102     | Pottery |
| 365               | C    | 1      | 102     | Pottery |
| 366               | C    | 1      | 102     | Pottery |
| 367               | C    | 4      | 401     | Pottery |
| 368               | C    | 5      | 502     | Pottery |
| 369               | C    | 5      | 502     | Pottery |
| 370               | C    | 5      | 502     | Pottery |
| 371               | C    | 5      | 502     | Pottery |
| 372               | C    | 5      | 502     | Pottery |
| 373               | C    | 5      | 502     | Pottery |
| 374               | C    | 5      | 502     | Pottery |
| 375               | C    | 5      | 502     | Pottery |
| 376               | C    | 5      | 502     | Pottery |
| 377               | C    | 5      | 502     | Pottery |
| 378               | C    | 5      | 502     | Pottery |
| 379               | C    | 5      | 502     | Pottery |
| 380               | C    | 5      | 502     | Pottery |
| 381               | C    | 5      | 502     | Pottery |
| 382               | C    | 5      | 502     | VOID    |
| 383               | G    | 7      | 704     | Pottery |
| 384               | G    | 7      | 710     | Pottery |
| 385               | G    | 7      | 710     | Pottery |
| 386               | G    | 7      | 705     | Pottery |
| 387               | G    | 7      | 707     | Pottery |
| 388               | G    | 7      | 714     | Pottery |
| 389               | G    | 7      | 714     | Pottery |
| 390               | G    | 7      | 714     | Pottery |
| 391               | G    | 7      | 701     | Pottery |
| 392               | G    | 7      | 701     | Pottery |
| 393               | G    | 7      | 701     | Pottery |

|     |   |     |              |         |
|-----|---|-----|--------------|---------|
| 394 | G | 7   | 701          | Pottery |
| 395 | G | 7   | 701          | Pottery |
| 396 | G | 7   | 701          | Pottery |
| 397 | G | 7   | 701          | Pottery |
| 398 | G | 7   | 701          | Pottery |
| 399 | G | 7   | 701          | Pottery |
| 400 | G | 7   | 701          | Pottery |
| 401 | G | 7   | 701          | Pottery |
| 402 | G | 7   | 701          | Pottery |
| 403 | G | 7   | 701          | Pottery |
| 404 | G | 7   | 701          | Pottery |
| 405 | G | 7   | 701          | Pottery |
| 406 | G | 7   | 701          | Pottery |
| 407 | G | 7   | 701          | Pottery |
| 408 | G | 7   | 701          | Pottery |
| 409 | G | 7   | 701          | Pottery |
| 410 | G | 7   | 701          | Pottery |
| 411 | G | 7   | 701          | Pottery |
| 412 | G | 7   | 701          | Pottery |
| 413 | G | 8   | 801          | Pottery |
| 414 | G | 8   | 801          | Pottery |
| 415 | G | 8   | 804          | Pottery |
| 416 | G | 8   | 803          | Pottery |
| 417 | G | 8   | 803          | Pottery |
| 418 | G | 8   | 803          | Pottery |
| 419 | G | 8   | 803          | Pottery |
| 420 | G | 9A  | 929          | Pottery |
| 421 | G | 9A  | 931          | Pottery |
| 422 | G | 9A  | 931          | Pottery |
| 423 | G | 9A  | 931          | Pottery |
| 424 | G | 9A  | 931          | Pottery |
| 425 | G | 9A  | 931          | Pottery |
| 426 | G | 9A  | 930          | Pottery |
| 427 | G | 9A  | 935          | Pottery |
| 428 | G | 9A  | 935          | Pottery |
| 429 | G | 9B  | 902          | Pottery |
| 430 | G | 9B  | 908          | Pottery |
| 431 | G | 9B  | 908          | Pottery |
| 432 | G | 9B  | 908          | Pottery |
| 433 | G | 9B  | 911          | Pottery |
| 434 | G | 9B  | 911          | Pottery |
| 435 | G | 9B  | Unstratified | Pottery |
| 436 | G | 10  | 1005         | Pottery |
| 437 | G | 10  | 1005         | Pottery |
| 438 | G | 10  | 1005         | Pottery |
| 439 | G | 10  | 1005         | Pottery |
| 440 | G | 11  | 1102         | Pottery |
| 441 | G | 11  | 1102         | Pottery |
| 442 | G | 11  | 1103         | Pottery |
| 443 | G | 11  | 1103         | Pottery |
| 444 | G | 12  | 1201         | Pottery |
| 445 | G | 13B | 1301         | Pottery |
| 446 | G | 13B | 1301         | Pottery |
| 447 | G | 13B | 1303         | Pottery |
| 448 | G | 13B | 1303         | Pottery |
| 449 | G | 13B | 1303         | Pottery |
| 450 | G | 13B | 1303         | Pottery |
| 451 | G | 13B | 1303         | Pottery |
| 452 | G | 13B | 1304         | Pottery |

|     |   |     |              |         |
|-----|---|-----|--------------|---------|
| 453 | G | 13B | 1304         | Pottery |
| 454 | G | 13B | 1304         | Pottery |
| 455 | G | 13B | 1308         | Pottery |
| 456 | G | 13B | 1308         | Pottery |
| 457 | G | 13B | 1308         | Pottery |
| 458 | G | 13B | 1308         | Pottery |
| 459 | G | 13B | 1308         | Pottery |
| 460 | G | 13a | 1325         | Pottery |
| 461 | G | 13B | Unstratified | Pottery |
| 462 | G | 14  | 1401         | Pottery |
| 463 | G | 14  | 1401         | Pottery |
| 464 | G | 14  | 1401         | Pottery |
| 465 | G | 14  | 1401         | Pottery |
| 466 | G | 14  | 1402         | Pottery |
| 467 | G | 14  | 1402         | Pottery |
| 468 | G | 14  | 1402         | Pottery |
| 469 | G | 14  | 1402         | Pottery |
| 470 | G | 14  | 1404         | Pottery |
| 471 | G | 14  | 1404         | Pottery |
| 472 | G | 15A | 1504         | Pottery |
| 473 | G | 15B | 1501         | Pottery |
| 474 | G | 15B | 1502         | Pottery |
| 475 | G | 15B | Unstratified | Pottery |
| 476 | G | 15B | Unstratified | Pottery |
| 477 | G | 16  | 1601         | Pottery |
| 478 | G | 16  | 1601         | Pottery |
| 479 | G | 16  | 1601         | Pottery |
| 480 | G | 16  | 1601         | Pottery |
| 481 | G | 16  | 1601         | Pottery |
| 482 | G | 16  | 1601         | Pottery |
| 483 | G | 16  | 1601         | Pottery |
| 484 | G | 16  | 1601         | Pottery |
| 485 | G | 16  | 1601         | Pottery |
| 486 | G | 16  | 1605         | Pottery |
| 487 | G | 16  | 1605         | Pottery |
| 488 | G | 17  | Unstratified | Pottery |
| 489 | T | 20  | 2001         | Pottery |
| 490 | T | 20  | 2011         | Pottery |
| 491 | T | 21  | 2101         | Pottery |
| 492 | T | 21  | 2101         | Pottery |
| 493 | T | 21  | 2101         | Pottery |
| 494 | T | 21  | 2101         | Pottery |
| 495 | T | 21  | 2101         | Pottery |
| 496 | T | 21  | 2101         | Pottery |
| 497 | T | 21  | 2101         | Pottery |
| 498 | T | 21  | 2101         | Pottery |
| 499 | T | 21  | 2101         | Pottery |
| 500 | T | 21  | 2101         | Pottery |
| 504 | T | 21  | 2101         | Pottery |
| 505 | T | 21  | 2101         | Pottery |
| 506 | T | 21  | 2101         | Pottery |
| 507 | T | 21  | 2101         | Pottery |
| 508 | T | 21  | 2101         | Pottery |
| 509 | T | 21  | 2101         | Pottery |
| 510 | T | 21  | 2101         | Pottery |
| 511 | T | 21  | 2101         | Pottery |
| 512 | T | 21  | 2101         | Pottery |
| 513 | T | 21  | 2101         | Pottery |
| 514 | T | 21  | 2101         | Pottery |

|          |   |    |      |         |
|----------|---|----|------|---------|
| 515      | T | 21 | 2101 | Pottery |
| 516      | T | 21 | 2101 | Pottery |
| 517      | T | 21 | 2101 | Pottery |
| 518      | T | 21 | 2101 | Pottery |
| 519      | T | 21 | 2101 | Pottery |
| 520      | T | 21 | 2101 | Pottery |
| 521      | T | 21 | 2101 | Pottery |
| 522      | T | 21 | 2101 | Pottery |
| 523      | T | 21 | 2101 | Pottery |
| 524      | T | 21 | 2101 | Pottery |
| 525      | T | 21 | 2101 | Pottery |
| 526      | T | 21 | 2101 | Pottery |
| 527      | T | 21 | 2101 | Pottery |
| 528      | T | 21 | 2101 | Pottery |
| 529      | T | 21 | 2101 | Pottery |
| 530      | T | 21 | 2101 | Pottery |
| 531      | T | 21 | 2101 | Pottery |
| 532      | T | 21 | 2101 | Pottery |
| 533      | T | 21 | 2101 | Pottery |
| 534      | T | 21 | 2101 | Pottery |
| 535      | T | 21 | 2101 | Pottery |
| 536      | T | 21 | 2101 | Pottery |
| 537      | T | 21 | 2101 | Pottery |
| 538      | T | 21 | 2101 | Pottery |
| 539      | T | 21 | 2101 | Pottery |
| 540      | T | 21 | 2101 | Pottery |
| 541      | T | 21 | 2101 | Pottery |
| 542      | T | 21 | 2101 | Pottery |
| 543      | T | 21 | 2101 | Pottery |
| 544      | T | 21 | 2101 | Pottery |
| 545      | T | 21 | 2101 | Pottery |
| 546      | T | 21 | 2101 | Pottery |
| 547      | T | 21 | 2101 | Pottery |
| 548      | T | 21 | 2101 | Pottery |
| 549      | T | 21 | 2101 | Pottery |
| 550      | T | 21 | 2101 | Pottery |
| 551      | T | 21 | 2101 | Pottery |
| 552      | T | 21 | 2101 | Pottery |
| 553      | T | 21 | 2101 | Pottery |
| 554      | T | 21 | 2101 | Pottery |
| 555      | T | 21 | 2101 | Pottery |
| 556      | T | 21 | 2101 | Pottery |
| 557      | T | 21 | 2101 | Pottery |
| 558      | T | 21 | 2101 | Pottery |
| 559      | T | 21 | 2101 | Pottery |
| 560      | T | 21 | 2101 | Pottery |
| 561      | T | 21 | 2101 | Pottery |
| 562      | T | 21 | 2101 | Pottery |
| 563      | T | 21 | 2101 | Pottery |
| 564      | T | 21 | 2101 | Pottery |
| 565      | T | 21 | 2101 | Pottery |
| 566      | T | 21 | 2104 | Pottery |
| 567      | T | 21 | 2104 | Pottery |
| 568      | T | 21 | 2104 | Pottery |
| 569      | T | 21 | 2104 | Pottery |
| 0569 (B) | T | 21 | 2104 | Pottery |
| 570      | T | 21 | 2104 | Pottery |
| 571      | T | 21 | 2104 | Pottery |
| 572      | T | 21 | 2104 | Pottery |



|          |   |     |                      |         |
|----------|---|-----|----------------------|---------|
| 573      | T | 21  | 2104                 | Pottery |
| 574      | T | 21  | 2104                 | Pottery |
| 575      | T | 21  | 2104                 | Pottery |
| 576      | T | 21  | 2104                 | Pottery |
| 577      | T | 21  | 2104                 | Pottery |
| 578      | T | 21  | 2104                 | Pottery |
| 579      | T | 21  | 2104                 | Pottery |
| 580      | T | 21  | 2104                 | Pottery |
| 581      | T | 21  | 2104                 | Pottery |
| 582      | T | 21  | 2104                 | Pottery |
| 0583 (B) | T | 22A | 2205                 | Pottery |
| 584      | T | 22A | 2205                 | Pottery |
| 585      | T | 22A | 2205                 | Pottery |
| 586      | T | 22A | 2205                 | Pottery |
| 587      | T | 22A | 2205                 | Pottery |
| 588      | T | 22A | 2205                 | Pottery |
| 589      | T | 22A | 2205                 | Pottery |
| 590      | T | 22A | 2205                 | Pottery |
| 591      | T | 22A | 2205                 | Pottery |
| 592      | T | 22A | 2205                 | Pottery |
| 593      | T | 22A | 2205                 | Pottery |
| 594      | T | 22A | 2205                 | Pottery |
| 595      | T | 22A | 2205                 | Pottery |
| 596      | T | 22A | 2205                 | Pottery |
| 597      | T | 22A | 2205                 | Pottery |
| 598      | T | 22A | 2205                 | Pottery |
| 599      | T | 22A | 2205                 | Pottery |
| 600      | T | 22A | 2206                 | Pottery |
| 601      | T | 22B | 2203                 | Pottery |
| 602      | T | 22B | 2217                 | Pottery |
| 603      | T | 22B | 2217                 | Pottery |
| 604      | T | 22B | Unstratified (BAG 1) | Pottery |
| 605      | T | 22B | Unstratified (BAG 1) | Pottery |
| 606      | T | 22B | Unstratified(BAG 1)  | Pottery |
| 607      | T | 22B | Unstratified (BAG 1) | Pottery |
| 608      | T | 22B | Unstratified (BAG 1) | Pottery |
| 609      | T | 22B | Unstratified (BAG 2) | Pottery |
| 610      | T | 22B | Unstratified (BAG 2) | Pottery |
| 611      | T | 22B | Unstratified (BAG 2) | Pottery |
| 612      | T | 22B | Unstratified (BAG 2) | Pottery |
| 613      | T | 22B | Unstratified (BAG 2) | Pottery |
| 614      | T | 22C | 2215                 | Pottery |
| 615      | T | 22C | 2215                 | Pottery |
| 616      | T | 23C | 2301                 | Pottery |
| 617      | T | 23C | 2301                 | Pottery |
| 618      | T | 23C | 2301                 | Pottery |
| 619      | T | 23C | 2304                 | Pottery |
| 620      | T | 23C | 2304                 | Pottery |
| 621      | T | 23C | 2306                 | Pottery |
| 622      | T | 23C | 2306                 | Pottery |
| 623      | T | 23C | 2306                 | Pottery |
| 624      | T | 25A | 2501                 | Pottery |
| 625      | T | 25A | 2501                 | Pottery |
| 626      | T | 25A | 2501                 | Pottery |
| 627      | T | 25A | 2501                 | Pottery |
| 628      | T | 25A | 2501                 | Pottery |
| 629      | T | 25A | 2501                 | Pottery |
| 630      | T | 25A | 2501                 | Pottery |
| 631      | T | 25A | 2501                 | Pottery |

|     |   |     |      |         |
|-----|---|-----|------|---------|
| 632 | T | 25A | 2501 | Pottery |
| 633 | T | 25A | 2501 | Pottery |
| 634 | T | 25A | 2501 | Pottery |
| 635 | T | 25A | 2501 | Pottery |
| 636 | T | 25A | 2501 | Pottery |
| 637 | T | 25A | 2501 | Pottery |
| 638 | T | 25A | 2501 | Pottery |
| 639 | T | 25A | 2501 | Pottery |
| 640 | T | 25A | 2501 | Pottery |
| 641 | T | 25A | 2501 | Pottery |
| 642 | T | 25A | 2501 | Pottery |
| 643 | T | 25A | 2501 | Pottery |
| 644 | T | 25A | 2501 | Pottery |
| 645 | T | 25A | 2501 | Pottery |
| 646 | T | 25A | 2501 | Pottery |
| 647 | T | 25A | 2501 | Pottery |
| 648 | T | 25A | 2501 | Pottery |
| 649 | T | 25A | 2501 | Pottery |
| 650 | T | 25A | 2501 | Pottery |
| 651 | T | 25A | 2501 | Pottery |
| 652 | T | 25A | 2501 | Pottery |
| 653 | T | 25A | 2501 | Pottery |
| 654 | T | 25A | 2501 | Pottery |
| 655 | T | 25A | 2501 | Pottery |
| 656 | T | 25A | 2501 | Pottery |
| 657 | T | 25A | 2501 | Pottery |
| 658 | T | 25A | 2501 | Pottery |
| 659 | T | 25A | 2501 | Pottery |
| 660 | T | 25A | 2501 | Pottery |
| 661 | T | 25A | 2501 | Pottery |
| 662 | T | 25A | 2501 | Pottery |
| 663 | T | 25A | 2501 | Pottery |
| 664 | T | 25A | 2501 | Pottery |
| 665 | T | 25A | 2501 | Pottery |
| 666 | T | 25A | 2501 | Pottery |
| 667 | T | 25A | 2501 | Pottery |
| 668 | T | 25A | 2501 | Pottery |
| 669 | T | 25A | 2501 | Pottery |
| 670 | T | 25A | 2501 | Pottery |
| 671 | T | 25A | 2501 | Pottery |
| 672 | T | 25A | 2501 | Pottery |
| 673 | T | 25A | 2501 | Pottery |
| 674 | T | 25A | 2501 | Pottery |
| 675 | T | 25A | 2501 | Pottery |
| 676 | T | 25A | 2503 | Pottery |
| 677 | T | 25A | 2503 | Pottery |
| 678 | T | 25A | 2503 | Pottery |
| 679 | T | 25A | 2503 | Pottery |
| 680 | T | 25A | 2503 | Pottery |
| 681 | T | 25A | 2503 | Pottery |
| 682 | T | 25A | 2503 | Pottery |
| 683 | T | 25A | 2503 | Pottery |
| 684 | T | 25A | 2503 | Pottery |
| 685 | T | 25A | 2503 | Pottery |
| 686 | T | 25A | 2503 | Pottery |
| 687 | T | 25A | 2503 | Pottery |
| 688 | T | 25A | 2503 | Pottery |
| 689 | T | 25A | 2503 | Pottery |
| 690 | T | 25A | 2503 | Pottery |

|     |   |     |              |         |
|-----|---|-----|--------------|---------|
| 691 | T | 25A | 2503         | Pottery |
| 692 | T | 25A | 2503         | Pottery |
| 693 | T | 25A | 2503         | Pottery |
| 694 | T | 25A | 2503         | Pottery |
| 695 | T | 25A | 2503         | Pottery |
| 696 | T | 25A | 2503         | Pottery |
| 697 | T | 25A | 2503         | Pottery |
| 698 | T | 25A | 2503         | Pottery |
| 699 | T | 25A | 2503         | Pottery |
| 700 | T | 25A | 2503         | Pottery |
| 701 | T | 25A | 2503         | Pottery |
| 702 | T | 25A | 2503         | Pottery |
| 703 | T | 25A | 2503         | Pottery |
| 704 | T | 25A | 2504         | Pottery |
| 705 | T | 25A | 2504         | Pottery |
| 706 | T | 25A | 2504         | Pottery |
| 707 | T | 25A | 2504         | Pottery |
| 708 | T | 25A | 2504         | Pottery |
| 709 | T | 25A | 2504         | Pottery |
| 710 | T | 25A | 2504         | Pottery |
| 711 | T | 25A | 2504         | Pottery |
| 712 | T | 25A | 2504         | Pottery |
| 713 | T | 25A | 2504         | Pottery |
| 714 | T | 25A | 2504         | Pottery |
| 715 | T | 25A | 2504         | Pottery |
| 716 | T | 25A | 2504         | Pottery |
| 717 | T | 25A | 2504         | Pottery |
| 718 | T | 25A | 2504         | Pottery |
| 719 | T | 25A | 2504         | Pottery |
| 720 | T | 25A | 2504         | Pottery |
| 721 | T | 25A | 2504         | Pottery |
| 722 | T | 25A | 2504         | Pottery |
| 723 | T | 25A | 2504         | Pottery |
| 724 | T | 25A | 2504         | Pottery |
| 725 | T | 25A | 2507         | Pottery |
| 726 | T | 25A | 2507         | Pottery |
| 727 | T | 25A | 2507         | Pottery |
| 728 | T | 25A | 2507         | Pottery |
| 729 | T | 25A | 2507         | Pottery |
| 730 | T | 25A | 2507         | Pottery |
| 731 | T | 25A | 2507         | Pottery |
| 732 | T | 25A | 2507         | Pottery |
| 733 | T | 25A | 2507         | Pottery |
| 734 | T | 25A | 2507         | Pottery |
| 735 | T | 25A | 2507         | Pottery |
| 736 | T | 25A | 2507         | Pottery |
| 737 | T | 25A | 2507         | Pottery |
| 738 | T | 25A | 2507         | Pottery |
| 739 | T | 25A | 2507         | Pottery |
| 740 | T | 25A | 2507         | Pottery |
| 741 | T | 25A | 2507         | Pottery |
| 742 | T | 25A | 2507         | Pottery |
| 743 | T | 25A | 2507         | Pottery |
| 744 | T | 25A | 2507         | Pottery |
| 745 | T | 25A | 2507         | Pottery |
| 746 | T | 25A | 2507         | Pottery |
| 747 | T | 25A | 2507         | Pottery |
| 748 | T | 25A | 2508         | Pottery |
| 749 | T | 25A | Unstratified | Pottery |

|     |   |     |      |         |
|-----|---|-----|------|---------|
| 750 | T | 25B | 2510 | Pottery |
| 751 | T | 25B | 2510 | Pottery |
| 752 | T | 25B | 2510 | Pottery |
| 753 | T | 25B | 2510 | Pottery |
| 754 | T | 25B | 2510 | Pottery |
| 755 | T | 25B | 2510 | Pottery |
| 756 | T | 25B | 2510 | Pottery |
| 757 | T | 25B | 2510 | Pottery |
| 758 | T | 25B | 2510 | Pottery |
| 759 | T | 25B | 2510 | Pottery |
| 760 | T | 25B | 2510 | Pottery |
| 761 | T | 25B | 2510 | Pottery |
| 762 | T | 25B | 2510 | Pottery |
| 763 | T | 25B | 2510 | Pottery |
| 764 | T | 25B | 2510 | Pottery |
| 765 | T | 25B | 2510 | Pottery |
| 766 | T | 25B | 2510 | Pottery |
| 767 | T | 25B | 2510 | Pottery |
| 768 | T | 25B | 2510 | Pottery |
| 769 | T | 25B | 2510 | Pottery |
| 770 | T | 25B | 2510 | Pottery |
| 771 | T | 25B | 2510 | Pottery |
| 772 | T | 25B | 2510 | Pottery |
| 773 | T | 25B | 2510 | Pottery |
| 774 | T | 25B | 2510 | Pottery |
| 775 | T | 25B | 2510 | Pottery |
| 776 | T | 25B | 2510 | Pottery |
| 777 | T | 25B | 2510 | Pottery |
| 778 | T | 25B | 2510 | Pottery |
| 779 | T | 25B | 2510 | Pottery |
| 780 | T | 25B | 2510 | Pottery |
| 781 | T | 25B | 2510 | Pottery |
| 782 | T | 25B | 2510 | Pottery |
| 783 | T | 25B | 2510 | Pottery |
| 784 | T | 25B | 2510 | Pottery |
| 785 | T | 25B | 2510 | Pottery |
| 786 | T | 25B | 2510 | Pottery |
| 787 | T | 25B | 2510 | Pottery |
| 788 | T | 25B | 2510 | Pottery |
| 789 | T | 25B | 2510 | Pottery |
| 790 | T | 25B | 2510 | Pottery |
| 791 | T | 25B | 2510 | Pottery |
| 792 | T | 25B | 2510 | Pottery |
| 793 | T | 25B | 2510 | Pottery |
| 794 | T | 25B | 2510 | Pottery |
| 795 | T | 25B | 2510 | Pottery |
| 796 | T | 25B | 2510 | Pottery |
| 797 | T | 25B | 2510 | Pottery |
| 798 | T | 25B | 2510 | Pottery |
| 799 | T | 25B | 2510 | Pottery |
| 800 | T | 25B | 2510 | Pottery |
| 801 | T | 25B | 2510 | Pottery |
| 802 | T | 25B | 2510 | Pottery |
| 803 | T | 25B | 2510 | Pottery |
| 804 | T | 25B | 2510 | Pottery |
| 805 | T | 25B | 2510 | Pottery |
| 806 | T | 25B | 2510 | Pottery |
| 807 | T | 25B | 2510 | Pottery |
| 808 | T | 25B | 2510 | Pottery |

|     |   |     |      |         |
|-----|---|-----|------|---------|
| 809 | T | 25B | 2510 | Pottery |
| 810 | T | 25B | 2510 | Pottery |
| 811 | T | 25B | 2510 | Pottery |
| 812 | T | 25B | 2510 | Pottery |
| 813 | T | 25B | 2510 | Pottery |
| 814 | T | 25B | 2510 | Pottery |
| 815 | T | 25B | 2510 | Pottery |
| 816 | T | 25B | 2510 | Pottery |
| 817 | T | 25B | 2510 | Pottery |
| 818 | T | 25B | 2510 | Pottery |
| 819 | T | 25B | 2510 | Pottery |
| 820 | T | 25B | 2510 | Pottery |
| 821 | T | 25B | 2510 | Pottery |
| 822 | T | 25B | 2510 | Pottery |
| 823 | T | 25B | 2510 | Pottery |
| 824 | T | 25B | 2510 | Pottery |
| 825 | T | 25B | 2510 | Pottery |
| 826 | T | 25B | 2510 | Pottery |
| 827 | T | 25B | 2510 | Pottery |
| 828 | T | 25B | 2510 | Pottery |
| 829 | T | 25B | 2510 | Pottery |
| 830 | T | 25B | 2510 | Pottery |
| 831 | T | 25B | 2510 | Pottery |
| 832 | T | 25B | 2510 | Pottery |
| 833 | T | 25B | 2510 | Pottery |
| 834 | T | 25B | 2510 | Pottery |
| 835 | T | 25B | 2510 | Pottery |
| 836 | T | 25B | 2510 | Pottery |
| 837 | T | 25B | 2510 | Pottery |
| 838 | T | 25B | 2510 | Pottery |
| 839 | T | 25B | 2510 | Pottery |
| 840 | T | 25B | 2510 | Pottery |
| 841 | T | 25B | 2510 | Pottery |
| 842 | T | 25B | 2512 | Pottery |
| 843 | T | 25B | 2512 | Pottery |
| 844 | T | 25B | 2512 | Pottery |
| 845 | T | 25B | 2512 | Pottery |
| 846 | T | 25B | 2512 | Pottery |
| 847 | T | 25B | 2512 | Pottery |
| 848 | T | 25B | 2512 | Pottery |
| 849 | T | 25B | 2512 | Pottery |
| 850 | T | 25B | 2512 | Pottery |
| 851 | T | 25B | 2512 | Pottery |
| 852 | T | 25B | 2512 | Pottery |
| 853 | T | 25B | 2512 | Pottery |
| 854 | T | 25B | 2512 | Pottery |
| 855 | T | 25B | 2512 | Pottery |
| 856 | T | 25B | 2512 | Pottery |
| 857 | T | 25B | 2512 | Pottery |
| 858 | T | 25B | 2512 | Pottery |
| 859 | T | 25B | 2512 | Pottery |
| 860 | T | 25B | 2512 | Pottery |
| 861 | T | 25B | 2512 | Pottery |
| 862 | T | 25B | 2512 | Pottery |
| 863 | T | 25B | 2512 | Pottery |
| 864 | T | 25B | 2512 | Pottery |
| 865 | T | 25B | 2512 | Pottery |
| 866 | T | 25B | 2512 | Pottery |
| 867 | T | 25B | 2512 | Pottery |

|     |   |     |      |         |
|-----|---|-----|------|---------|
| 868 | T | 25B | 2512 | Pottery |
| 869 | T | 25B | 2512 | Pottery |
| 870 | T | 25B | 2512 | Pottery |
| 871 | T | 25B | 2512 | Pottery |
| 872 | T | 25B | 2512 | Pottery |
| 873 | T | 25B | 2512 | Pottery |
| 874 | T | 25B | 2514 | Pottery |
| 875 | T | 25B | 2514 | Pottery |
| 876 | T | 25B | 2514 | Pottery |
| 877 | T | 25B | 2514 | Pottery |
| 878 | T | 25B | 2514 | Pottery |
| 879 | T | 25B | 2514 | Pottery |
| 880 | T | 25B | 2514 | Pottery |
| 881 | T | 25B | 2515 | Pottery |
| 882 | T | 25B | 2515 | Pottery |
| 883 | T | 25B | 2515 | Pottery |
| 884 | T | 25B | 2515 | Pottery |
| 885 | T | 25B | 2515 | Pottery |
| 886 | T | 25B | 2515 | Pottery |
| 887 | T | 25B | 2515 | Pottery |
| 888 | T | 25B | 2515 | Pottery |
| 889 | T | 25B | 2515 | Pottery |
| 890 | T | 25B | 2515 | Pottery |
| 891 | T | 25B | 2515 | Pottery |
| 892 | T | 25B | 2515 | Pottery |
| 893 | T | 25B | 2515 | Pottery |
| 894 | T | 25B | 2515 | Pottery |
| 895 | T | 25B | 2515 | Pottery |
| 896 | T | 25B | 2515 | Pottery |
| 897 | T | 25B | 2515 | Pottery |
| 898 | T | 25B | 2515 | Pottery |
| 899 | T | 25B | 2515 | Pottery |
| 900 | T | 25B | 2515 | Pottery |
| 901 | T | 25B | 2515 | Pottery |
| 902 | T | 25B | 2515 | Pottery |
| 903 | T | 25B | 2515 | Pottery |
| 904 | T | 25B | 2515 | Pottery |
| 905 | T | 25B | 2515 | Pottery |
| 906 | T | 25B | 2515 | Pottery |
| 907 | T | 25B | 2515 | Pottery |
| 908 | T | 25B | 2515 | Pottery |
| 909 | T | 25B | 2515 | Pottery |
| 910 | T | 25B | 2515 | Pottery |
| 911 | T | 25B | 2515 | Pottery |
| 912 | T | 25B | 2515 | Pottery |
| 913 | T | 25B | 2515 | Pottery |
| 914 | T | 25B | 2515 | Pottery |
| 915 | T | 25B | 2515 | Pottery |
| 916 | T | 25B | 2515 | Pottery |
| 917 | T | 25B | 2515 | Pottery |
| 918 | T | 25B | 2515 | Pottery |
| 919 | T | 25B | 2515 | Pottery |
| 920 | T | 25B | 2515 | Pottery |
| 921 | T | 25B | 2515 | Pottery |
| 922 | T | 25B | 2515 | Pottery |
| 923 | T | 25B | 2515 | Pottery |
| 924 | T | 25B | 2515 | Pottery |
| 925 | T | 25B | 2515 | Pottery |
| 926 | T | 25B | 2515 | Pottery |

|     |   |     |              |         |
|-----|---|-----|--------------|---------|
| 927 | T | 25B | 2515         | Pottery |
| 928 | T | 25B | 2515         | Pottery |
| 929 | T | 25B | 2515         | Pottery |
| 930 | T | 25B | 2515         | Pottery |
| 931 | T | 25B | 2515         | Pottery |
| 932 | T | 25B | 2515         | Pottery |
| 933 | T | 25B | 2515         | Pottery |
| 934 | T | 25B | 2515         | Pottery |
| 935 | T | 25B | 2515         | Pottery |
| 936 | T | 25B | 2515         | Pottery |
| 937 | T | 25B | 2515         | Pottery |
| 938 | T | 25B | 2515         | Pottery |
| 939 | T | 25B | 2517         | Pottery |
| 940 | T | 25B | 2517         | Pottery |
| 941 | T | 25B | 2517         | Pottery |
| 942 | T | 25B | 2522         | Pottery |
| 943 | T | 25B | 2522         | Pottery |
| 944 | T | 25B | 2522         | Pottery |
| 945 | T | 25C | Unstratified | Pottery |
| 946 | T | 25C | Unstratified | Pottery |
| 947 | T | 25C | Unstratified | Pottery |
| 948 | T | 25C | Unstratified | Pottery |
| 949 | T | 25C | Unstratified | Pottery |
| 950 | T | 25C | Unstratified | Pottery |
| 951 | T | 25C | Unstratified | Pottery |
| 952 | T | 25C | Unstratified | Pottery |
| 953 | T | 25C | Unstratified | Pottery |
| 954 | T | 25C | Unstratified | Pottery |
| 955 | T | 25C | Unstratified | Pottery |
| 956 | T | 25C | Unstratified | Pottery |
| 957 | T | 25C | Unstratified | Pottery |
| 958 | T | 25C | Unstratified | Pottery |
| 959 | T | 25C | Unstratified | Pottery |
| 960 | T | 25C | Unstratified | Pottery |
| 961 | T | 25C | Unstratified | Pottery |
| 962 | T | 25C | Unstratified | Pottery |
| 963 | T | 25C | Unstratified | Pottery |
| 964 | T | 25C | Unstratified | Pottery |
| 964 | T | 25C | Unstratified | Pottery |
| 965 | T | 25C | Unstratified | Pottery |
| 966 | E | 26A | 2601         | Pottery |
| 967 | E | 26A | 2607         | Pottery |
| 968 | E | 26B | 2601         | Pottery |
| 969 | E | 26B | 2601         | Pottery |
| 970 | E | 26B | 2601         | Pottery |
| 971 | E | 26B | 2601         | Pottery |
| 972 | E | 26B | 2613         | Pottery |
| 973 | E | 26B | 2613         | Pottery |
| 974 | T | 27  | 2701         | Pottery |
| 975 | T | 27  | 2701         | Pottery |
| 976 | T | 27  | 2701         | Pottery |
| 977 | T | 27  | 2701         | Pottery |
| 978 | T | 27  | 2701         | Pottery |
| 979 | T | 27  | 2701         | Pottery |
| 980 | T | 27  | 2701         | Pottery |
| 981 | T | 27  | 2701         | Pottery |
| 982 | T | 27  | 2701         | Pottery |
| 983 | T | 27  | 2702         | Pottery |
| 984 | T | 27  | 2702         | Pottery |

|      |   |     |              |         |
|------|---|-----|--------------|---------|
| 985  | T | 27  | 2702         | Pottery |
| 986  | T | 27  | 2702         | Pottery |
| 987  | T | 27  | 2702         | Pottery |
| 988  | T | 27  | 2702         | Pottery |
| 989  | T | 27  | 2702         | Pottery |
| 990  | T | 27  | 2702         | Pottery |
| 991  | T | 27  | 2702         | Pottery |
| 992  | T | 27  | 2702         | Pottery |
| 993  | T | 27  | 2702         | Pottery |
| 994  | T | 27  | 2702         | Pottery |
| 995  | T | 27  | 2702         | Pottery |
| 996  | T | 27  | 2705         | Pottery |
| 997  | T | 27  | 2705         | Pottery |
| 998  | T | 27  | 2708         | Pottery |
| 999  | T | 28  | 2801         | Pottery |
| 1000 | T | 28  | 2801         | Pottery |
| 1001 | T | 28  | 2801         | Pottery |
| 1002 | T | 28  | 2801         | Pottery |
| 1003 | T | 28  | 2801         | Pottery |
| 1004 | T | 28  | 2801         | Pottery |
| 1005 | T | 28  | 2805         | Pottery |
| 1006 | T | 28  | 2805         | Pottery |
| 1007 | T | 28  | 2811         | Pottery |
| 1008 | T | 28  | 2811         | Pottery |
| 1009 | T | 28  | Unstratified | Pottery |
| 1010 | T | 28  | Unstratified | Pottery |
| 1011 | T | 28  | Unstratified | Pottery |
| 1012 | T | 28  | Unstratified | Pottery |
| 1013 | T | 28  | Unstratified | Pottery |
| 1014 | T | 28  | Unstratified | Pottery |
| 1015 | T | 28  | Unstratified | Pottery |
| 1016 | T | 28  | Unstratified | Pottery |
| 1017 | T | 28  | Unstratified | Pottery |
| 1018 | T | 28  | Unstratified | Pottery |
| 1019 | T | 28  | Unstratified | Pottery |
| 1020 | T | 28  | Unstratified | Pottery |
| 1021 | T | 28  | Unstratified | Pottery |
| 1022 | T | 28  | Unstratified | Pottery |
| 1023 | T | 28  | Unstratified | Pottery |
| 1024 | T | 28  | Unstratified | Pottery |
| 1025 | T | 28  | Unstratified | Pottery |
| 1026 | D | 29  | 2901         | Pottery |
| 1027 | D | 29  | 2901         | Pottery |
| 1028 | D | 29  | 2901         | Pottery |
| 1029 | D | 29  | 2901         | Pottery |
| 1030 | D | 29  | 2901         | Pottery |
| 1031 | D | 29  | 2902         | Pottery |
| 1032 | T | 30F | 3001         | Pottery |
| 1033 | T | 30F | 3001         | Pottery |
| 1034 | T | 30F | 3002         | Pottery |
| 1035 | T | 32  | 3201         | Pottery |
| 1036 | G | 7   | 707          | Pottery |
| 1037 | G | 7   | 707          | Pottery |
| 1038 | G | 7   | 707          | Pottery |
| 1039 | G | 7   | 707          | Pottery |
| 1040 | E | 26B | 2613         | Pottery |
| 1041 | E | 26B | 2613         | Pottery |
| 1042 | E | 26B | 2613         | Pottery |
| 1043 | E | 26B | 2613         | Pottery |



|      |   |     |              |                          |
|------|---|-----|--------------|--------------------------|
| 1044 | E | 26B | 2613         | Pottery                  |
| 1045 | T | 28  | 2801         | Pottery                  |
| 1046 | T | 23B | 2317         | Clay Pipe                |
| 1047 | T | 23B | 2317         | Clay Pipe                |
| 1048 | T | 23B | 2317         | Clay Pipe                |
| 1049 | T | 23B | 2317         | Clay Pipe                |
| 1050 | T | 23C | 2302         | Clay Pipe                |
| 1051 | T | 23C | 2302         | Clay Pipe                |
| 1052 | T | 23C | 2302         | Clay Pipe                |
| 1053 | T | 23D | 2321         | Clay Pipe                |
| 1054 | G | 9B  | 913          | Coin                     |
| 1055 | G | 9B  | 916          | Metal Strap Fitting 1/2  |
| 1056 | G | 9B  | 916          | Metal Strap Fitting 2/2  |
| 1057 | G | 11  | 1103         | Coin                     |
| 1058 | G | 12  | 1201         | Metal Mount              |
| 1059 | G | 13A | 1316         | Copper Object            |
| 1060 | G | 13B | 1301         | Coin                     |
| 1061 | G | 15A | 1506         | Copper Alloy seal matrix |
| 1062 | T | 23B | 2313         | Copper Pin               |
| 1063 | T | 23B | 2313         | Copper Alloy crotal bell |
| 1064 | T | 25A | 2501         | Shoe Buckle              |
| 1065 | T | 25B | 2515         | Metal Ring               |
| 1066 | E | 26B | 2603         | Metal Hook               |
| 1067 | G | 11  | 1103         | Musket Ball              |
| 1068 | T | 21  | 2101         | Musket Ball              |
| 1069 | T | 25A | 2501         | Bead 1/2                 |
| 1070 | T | 25A | 2501         | Bead 2/2                 |
| 1071 | T | 20  | 2011         | Gaming Piece             |
| 1072 | T | 25A | Unstratified | Gaming Piece             |
| 1073 | T | 25C | Unstratified | Gaming Piece             |
| 1074 | T | 25C | Unstratified | Gaming Piece             |
| 1075 | E | 26B | Unstratified | Spindle Whorl            |
| 1076 | C | 4   | 401          | Clay pipe                |
| 1077 | C | 4   | 401          | Clay pipe                |
| 1078 | D | 5   | 502          | Clay pipe                |
| 1079 | D | 5   | 502          | Clay pipe                |
| 1080 | D | 5   | 502          | Clay pipe                |
| 1081 | D | 5   | 502          | Clay pipe                |
| 1082 | G | 7   | 701          | Clay pipe                |
| 1083 | G | 7   | 701          | Clay pipe                |
| 1084 | G | 7   | 701          | Clay pipe                |
| 1085 | G | 7   | 701          | Clay pipe                |
| 1086 | G | 7   | 701          | Clay pipe                |
| 1087 | G | 8   | 804          | Clay pipe                |
| 1088 | G | 9A  | 929          | Clay pipe                |
| 1089 | G | 9A  | 931          | Clay pipe                |
| 1090 | G | 12  | 1201         | Clay pipe                |
| 1091 | G | 16  | 1601         | Clay pipe                |
| 1092 | G | 16  | 1602         | Clay pipe                |
| 1093 | G | 21  | 2101         | Clay pipe                |
| 1094 | G | 21  | 2104         | Clay pipe                |
| 1095 | G | 21  | 2104         | Clay pipe                |
| 1096 | T | 22  | 2203         | Clay pipe                |
| 1097 | T | 22  | 2205         | Clay pipe                |
| 1098 | T | 22  | 2205         | Clay pipe                |
| 1099 | T | 22  | 2205         | Clay pipe                |
| 1100 | T | 22  | 2205         | Clay pipe                |
| 1101 | T | 22  | Unstratified | Clay pipe                |
| 1102 | T | 22  | Unstratified | Clay pipe                |

|      |   |     |              |           |
|------|---|-----|--------------|-----------|
| 1103 | T | 23C | 2306         | Clay pipe |
| 1104 | T | 23C | Unstratified | Clay pipe |
| 1105 | T | 23C | Unstratified | Clay pipe |
| 1106 | T | 25A | 2501         | Clay pipe |
| 1107 | T | 25A | 2501         | Clay pipe |
| 1108 | T | 25A | 2501         | Clay pipe |
| 1109 | T | 25A | 2501         | Clay pipe |
| 1110 | T | 25A | 2501         | Clay pipe |
| 1111 | T | 25A | 2501         | Clay pipe |
| 1112 | T | 25A | 2502         | Clay pipe |
| 1113 | T | 25A | 2503         | Clay pipe |
| 1114 | T | 25A | 2504         | Clay pipe |
| 1115 | T | 25A | 2504         | Clay pipe |
| 1116 | T | 25A | 2504         | Clay pipe |
| 1117 | T | 25A | 2504         | Clay pipe |
| 1118 | T | 25A | 2504         | Clay pipe |
| 1119 | T | 25A | 2504         | Clay pipe |
| 1120 | T | 25A | 2504         | Clay pipe |
| 1121 | T | 25A | 2504         | Clay pipe |
| 1122 | T | 25A | 2507         | Clay pipe |
| 1123 | T | 25A | 2507         | Clay pipe |
| 1124 | T | 25B | 2510         | Clay pipe |
| 1125 | T | 25B | 2510         | Clay pipe |
| 1126 | T | 25B | 2510         | Clay pipe |
| 1127 | T | 25B | 2510         | Clay pipe |
| 1128 | T | 25B | 2512         | Clay pipe |
| 1129 | T | 25B | 2512         | Clay pipe |
| 1130 | T | 25B | 2512         | Clay pipe |
| 1131 | T | 25B | 2512         | Clay pipe |
| 1132 | T | 25B | 2512         | Clay pipe |
| 1133 | T | 25B | 2512         | Clay pipe |
| 1134 | T | 25B | 2515         | Clay pipe |
| 1135 | T | 25B | 2515         | Clay pipe |
| 1136 | T | 25B | 2516         | Clay pipe |
| 1137 | T | 25C | Unstratified | Clay pipe |
| 1138 | T | 25C | 2532         | Clay pipe |
| 1139 | E | 26A | 2601         | Clay pipe |
| 1140 | E | 26B | 2610         | Clay pipe |
| 1141 | E | 26B | 2613         | Clay pipe |
| 1142 | T | 27  | 2701         | Clay pipe |
| 1143 | T | 27  | 2701         | Clay pipe |
| 1144 | T | 27  | 2701         | Clay pipe |
| 1145 | T | 27  | 2701         | Clay pipe |
| 1146 | T | 27  | 2701         | Clay pipe |
| 1147 | T | 27  | 2701         | Clay pipe |
| 1148 | T | 27  | 2701         | Clay pipe |
| 1149 | T | 27  | 2701         | Clay pipe |
| 1150 | T | 27  | 2701         | Clay pipe |
| 1151 | T | 27  | 2701         | Clay pipe |
| 1152 | T | 27  | 2701         | Clay pipe |
| 1153 | T | 28  | 2805         | Clay pipe |
| 1154 | T | 28  | 2807         | Clay pipe |
| 1155 | T | 28  | 2807         | Clay pipe |
| 1156 | T | 28  | 2807         | Clay pipe |
| 1157 | T | 28  | 2807         | Clay pipe |
| 1158 | D | 29  | 2901         | Clay pipe |
| 1159 | D | 29  | 2901         | Clay pipe |
| 1160 | D | 29  | 2901         | Clay pipe |
| 1161 | D | 29  | 2901         | Clay pipe |

|      |   |     |      |                   |
|------|---|-----|------|-------------------|
| 1162 | D | 29  | 2902 | Clay pipe         |
| 1163 | C | 1   | 102  | Glass Bottle Base |
| 1164 | C | 2   | 201  | Window Glass      |
| 1165 | D | 5   | 502  | Glass             |
| 1166 | D | 5   | 502  | Glass             |
| 1167 | D | 5   | 502  | Glass             |
| 1168 | D | 5   | 502  | Glass             |
| 1169 | D | 5   | 502  | Glass             |
| 1170 | D | 5   | 502  | Glass             |
| 1171 | G | 8   | 801  | Glass             |
| 1172 | G | 8   | 801  | Glass             |
| 1173 | G | 8   | 804  | Glass             |
| 1174 | G | 9   | 926  | Glass Droplet     |
| 1175 | G | 10  | 1001 | Glass             |
| 1176 | G | 10  | 1001 | Glass             |
| 1177 | G | 10  | 1001 | Glass             |
| 1178 | G | 10  | 1001 | Glass             |
| 1179 | G | 10  | 1001 | Glass             |
| 1180 | G | 10  | 1001 | Glass             |
| 1181 | G | 10  | 1001 | Glass             |
| 1182 | G | 10  | 1001 | Glass             |
| 1183 | G | 12  | 1202 | Window Glass      |
| 1184 | G | 12  | 1202 | Window Glass      |
| 1185 | G | 12  | 1207 | Window Glass      |
| 1186 | G | 12  | 1207 | Window Glass      |
| 1187 | G | 12  | 1207 | Window Glass      |
| 1188 | G | 12  | 1210 | Window Glass      |
| 1189 | G | 12  | 1210 | Window Glass      |
| 1190 | G | 14  | 1401 | Glass             |
| 1191 | G | 16  | 1601 | Glass             |
| 1192 | G | 16  | 1601 | Glass             |
| 1193 | G | 16  | 1601 | Glass             |
| 1194 | G | 16  | 1612 | Glass             |
| 1195 | G | 17  | 1701 | Glass Bottle Neck |
| 1196 | G | 17  | 1701 | Glass             |
| 1197 | G | 17  | 1702 | Glass             |
| 1198 | G | 17  | 1702 | Glass             |
| 1199 | G | 17  | 1702 | Glass             |
| 1200 | G | 17  | 1702 | Glass             |
| 1201 | G | 17  | 1702 | Glass             |
| 1202 | G | 17  | 1702 | Glass             |
| 1203 | G | 17  | 1703 | Window Glass      |
| 1204 | T | 20  | 2011 | Glass             |
| 1205 | T | 21  | 2101 | Glass             |
| 1206 | T | 21  | 2101 | Glass             |
| 1207 | T | 21  | 2101 | Glass             |
| 1208 | T | 21  | 2101 | Glass             |
| 1209 | T | 21  | 2101 | Glass             |
| 1210 | T | 21  | 2101 | Glass             |
| 1211 | T | 21  | 2101 | Glass             |
| 1212 | T | 21  | 2101 | Glass             |
| 1213 | T | 21  | 2104 | Glass             |
| 1214 | T | 21  | 2104 | Glass             |
| 1215 | T | 21  | 2104 | Glass             |
| 1216 | T | 21  | 2104 | Glass             |
| 1217 | T | 21  | 2104 | Glass             |
| 1218 | T | 22A | 2205 | Glass             |
| 1219 | T | 22A | 2205 | Glass             |
| 1220 | T | 22A | 2205 | Glass             |

|      |   |     |              |                   |
|------|---|-----|--------------|-------------------|
| 1221 | T | 22A | 2205         | Glass             |
| 1222 | T | 22A | 2205         | Glass             |
| 1223 | T | 22A | 2205         | Glass             |
| 1224 | T | 22A | 2205         | Glass             |
| 1225 | T | 22A | 2205         | Glass             |
| 1226 | T | 22A | 2205         | Glass             |
| 1227 | T | 22A | 2205         | Glass             |
| 1228 | T | 22B | Unstratified | Glass             |
| 1229 | T | 25A | 2500         | Glass Bottle Base |
| 1230 | T | 25A | 2501         | Glass             |
| 1231 | T | 25A | 2501         | Glass             |
| 1232 | T | 25A | 2501         | Glass Bottle Base |
| 1233 | T | 25A | 2501         | Glass Bottle Base |
| 1234 | T | 25A | 2501         | Glass Bottle Base |
| 1235 | T | 25A | 2501         | Glass Bottle Base |
| 1236 | T | 25A | 2501         | Glass             |
| 1237 | T | 25A | 2501         | Glass             |
| 1238 | T | 25A | 2501         | Glass             |
| 1239 | T | 25A | 2501         | Glass             |
| 1240 | T | 25A | 2501         | Glass             |
| 1241 | T | 25A | 2501         | Glass             |
| 1242 | T | 25A | 2501         | Glass             |
| 1243 | T | 25A | 2501         | Glass             |
| 1244 | T | 25A | 2501         | Glass             |
| 1245 | T | 25A | 2501         | Glass             |
| 1246 | T | 25A | 2501         | Glass             |
| 1247 | T | 25A | 2501         | Glass             |
| 1248 | T | 25A | 2501         | Glass             |
| 1249 | T | 25A | 2501         | Glass             |
| 1250 | T | 25A | 2501         | Glass             |
| 1251 | T | 25A | 2501         | Glass             |
| 1252 | T | 25A | 2501         | Glass             |
| 1253 | T | 25A | 2501         | Glass             |
| 1254 | T | 25A | 2501         | Glass             |
| 1255 | T | 25A | 2501         | Glass             |
| 1256 | T | 25A | 2501         | Glass             |
| 1257 | T | 25A | 2501         | Glass             |
| 1258 | T | 25A | 2501         | Glass             |
| 1259 | T | 25A | 2501         | Glass             |
| 1260 | T | 25A | 2501         | Glass             |
| 1261 | T | 25A | 2501         | Glass             |
| 1262 | T | 25A | 2501         | Glass             |
| 1263 | T | 25A | 2501         | Glass             |
| 1264 | T | 25A | 2501         | Glass             |
| 1265 | T | 25A | 2501         | Glass             |
| 1266 | T | 25A | 2501         | Glass             |
| 1267 | T | 25A | 2501         | Glass             |
| 1268 | T | 25A | 2501         | Glass             |
| 1269 | T | 25A | 2501         | Glass             |
| 1270 | T | 25A | 2501         | Glass             |
| 1271 | T | 25A | 2501         | Glass             |
| 1272 | T | 25A | 2501         | Glass             |
| 1273 | T | 25A | 2501         | Glass             |
| 1274 | T | 25A | 2501         | Glass             |
| 1275 | T | 25A | 2501         | Glass             |
| 1276 | T | 25A | 2501         | Glass             |
| 1277 | T | 25A | 2501         | Glass             |
| 1278 | T | 25A | 2501         | Glass             |
| 1279 | T | 25A | 2501         | Glass             |

|      |   |     |      |                   |
|------|---|-----|------|-------------------|
| 1280 | T | 25A | 2501 | Glass             |
| 1281 | T | 25A | 2501 | Glass             |
| 1282 | T | 25A | 2501 | Glass             |
| 1283 | T | 25A | 2501 | Glass             |
| 1284 | T | 25A | 2501 | Glass             |
| 1285 | T | 25A | 2501 | Glass             |
| 1286 | T | 25A | 2501 | Glass             |
| 1287 | T | 25A | 2501 | Glass             |
| 1288 | T | 25A | 2501 | Glass             |
| 1289 | T | 25A | 2501 | Glass             |
| 1290 | T | 25A | 2501 | Glass             |
| 1291 | T | 25A | 2501 | Glass             |
| 1292 | T | 25A | 2501 | Glass             |
| 1293 | T | 25A | 2501 | Glass             |
| 1294 | T | 25A | 2501 | Glass             |
| 1295 | T | 25A | 2501 | Glass             |
| 1296 | T | 25A | 2502 | Glass             |
| 1297 | T | 25A | 2502 | Glass             |
| 1298 | T | 25A | 2502 | Glass             |
| 1299 | T | 25A | 2502 | Glass             |
| 1300 | T | 25A | 2502 | Glass             |
| 1301 | T | 25A | 2502 | Glass             |
| 1302 | T | 25A | 2502 | Glass             |
| 1303 | T | 25A | 2502 | Glass             |
| 1304 | T | 25A | 2502 | Glass             |
| 1305 | T | 25A | 2502 | Glass             |
| 1306 | T | 25A | 2502 | Glass             |
| 1307 | T | 25A | 2502 | Glass             |
| 1308 | T | 25A | 2502 | Glass             |
| 1309 | T | 25A | 2502 | Glass             |
| 1310 | T | 25A | 2502 | Glass             |
| 1311 | T | 25A | 2502 | Glass             |
| 1312 | T | 25A | 2502 | Glass             |
| 1313 | T | 25A | 2502 | Glass             |
| 1314 | T | 25A | 2502 | Glass             |
| 1315 | T | 25A | 2502 | Glass             |
| 1316 | T | 25A | 2502 | Glass Bottle Base |
| 1317 | T | 25A | 2502 | Glass             |
| 1318 | T | 25A | 2502 | Glass             |
| 1319 | T | 25A | 2502 | Glass             |
| 1320 | T | 25A | 2502 | Glass             |
| 1321 | T | 25A | 2502 | Glass             |
| 1322 | T | 25A | 2502 | Glass             |
| 1323 | T | 25A | 2502 | Glass             |
| 1324 | T | 25A | 2502 | Glass             |
| 1325 | T | 25A | 2502 | Glass             |
| 1326 | T | 25A | 2503 | Glass             |
| 1327 | T | 25A | 2503 | Glass             |
| 1328 | T | 25A | 2503 | Glass             |
| 1329 | T | 25A | 2503 | Glass             |
| 1330 | T | 25A | 2503 | Glass Neck        |
| 1331 | T | 25A | 2504 | Glass             |
| 1332 | T | 25A | 2504 | Glass             |
| 1333 | T | 25A | 2504 | Glass             |
| 1334 | T | 25A | 2504 | Glass             |
| 1335 | T | 25A | 2504 | Glass             |
| 1336 | T | 25A | 2504 | Glass             |
| 1337 | T | 25A | 2504 | Glass             |
| 1338 | T | 25A | 2504 | Glass             |

|      |   |     |      |       |
|------|---|-----|------|-------|
| 1339 | T | 25A | 2504 | Glass |
| 1340 | T | 25A | 2504 | Glass |
| 1341 | T | 25A | 2504 | Glass |
| 1342 | T | 25A | 2504 | Glass |
| 1343 | T | 25A | 2504 | Glass |
| 1344 | T | 25A | 2504 | Glass |
| 1345 | T | 25A | 2504 | Glass |
| 1346 | T | 25A | 2504 | Glass |
| 1347 | T | 25A | 2504 | Glass |
| 1348 | T | 25A | 2504 | Glass |
| 1349 | T | 25A | 2504 | Glass |
| 1350 | T | 25A | 2504 | Glass |
| 1351 | T | 25A | 2507 | Glass |
| 1352 | T | 25A | 2507 | Glass |
| 1353 | T | 25A | 2507 | Glass |
| 1354 | T | 25A | 2507 | Glass |
| 1355 | T | 25A | 2507 | Glass |
| 1356 | T | 25A | 2507 | Glass |
| 1357 | T | 25A | 2507 | Glass |
| 1358 | T | 25A | 2507 | Glass |
| 1359 | T | 25A | 2507 | Glass |
| 1360 | T | 25A | 2507 | Glass |
| 1361 | T | 25A | 2507 | Glass |
| 1362 | T | 25A | 2507 | Glass |
| 1363 | T | 25A | 2507 | Glass |
| 1364 | T | 25A | 2507 | Glass |
| 1365 | T | 25A | 2507 | Glass |
| 1366 | T | 25A | 2507 | Glass |
| 1367 | T | 25A | 2507 | Glass |
| 1368 | T | 25A | 2507 | Glass |
| 1369 | T | 25A | 2507 | Glass |
| 1370 | T | 25A | 2507 | Glass |
| 1371 | T | 25A | 2507 | Glass |
| 1372 | T | 25A | 2507 | Glass |
| 1373 | T | 25A | 2507 | Glass |
| 1374 | T | 25A | 2507 | Glass |
| 1375 | T | 25A | 2507 | Glass |
| 1376 | T | 25A | 2507 | Glass |
| 1377 | T | 25A | 2507 | Glass |
| 1378 | T | 25A | 2507 | Glass |
| 1379 | T | 25A | 2507 | Glass |
| 1380 | T | 25A | 2507 | Glass |
| 1381 | T | 25A | 2507 | Glass |
| 1382 | T | 25A | 2507 | Glass |
| 1383 | T | 25A | 2507 | Glass |
| 1384 | T | 25A | 2507 | Glass |
| 1385 | T | 25A | 2507 | Glass |
| 1386 | T | 25A | 2507 | Glass |
| 1387 | T | 25A | 2507 | Glass |
| 1388 | T | 25A | 2507 | Glass |
| 1389 | T | 25A | 2507 | Glass |
| 1390 | T | 25A | 2507 | Glass |
| 1391 | T | 25A | 2507 | Glass |
| 1392 | T | 25A | 2507 | Glass |
| 1393 | T | 25A | 2507 | Glass |
| 1394 | T | 25A | 2507 | Glass |
| 1395 | T | 25A | 2507 | Glass |
| 1396 | T | 25A | 2507 | Glass |
| 1397 | T | 25A | 2507 | Glass |

|      |   |     |              |                   |
|------|---|-----|--------------|-------------------|
| 1398 | T | 25A | 2507         | Glass             |
| 1399 | T | 25B | 2510         | Glass             |
| 1400 | T | 25B | 2510         | Glass             |
| 1401 | T | 25B | 2510         | Glass             |
| 1402 | T | 25B | 2510         | Glass             |
| 1403 | T | 25B | 2510         | Glass             |
| 1404 | T | 25B | 2510         | Glass             |
| 1405 | T | 25B | 2510         | Glass             |
| 1406 | T | 25B | 2510         | Glass             |
| 1407 | T | 25B | 2510         | Glass             |
| 1408 | T | 25B | 2510         | Glass             |
| 1409 | T | 25B | 2510         | Glass             |
| 1410 | T | 25B | 2510         | Glass             |
| 1411 | T | 25B | 2510         | Glass             |
| 1412 | T | 25B | 2510         | Glass             |
| 1413 | T | 25B | 2510         | Glass             |
| 1414 | T | 25B | 2510         | Glass             |
| 1415 | T | 25B | 2510         | Glass             |
| 1416 | T | 25B | 2510         | Glass             |
| 1417 | T | 25B | 2510         | Glass             |
| 1418 | T | 25B | 2510         | Glass             |
| 1419 | T | 25B | 2510         | Glass             |
| 1420 | T | 25B | 2510         | Glass             |
| 1421 | T | 25B | 2510         | Glass             |
| 1422 | T | 25B | 2510         | Glass             |
| 1423 | T | 25B | 2510         | Glass             |
| 1424 | T | 25B | 2512         | Glass             |
| 1425 | T | 25B | 2512         | Glass             |
| 1426 | T | 25B | 2512         | Glass             |
| 1427 | T | 25B | 2512         | Glass             |
| 1428 | T | 25B | 2512         | Glass             |
| 1429 | T | 25B | 2512         | Glass             |
| 1430 | T | 25B | 2512         | Window Glass      |
| 1431 | T | 25B | 2512         | Window Glass      |
| 1432 | T | 25B | 2515         | Glass Bottle Base |
| 1433 | T | 25B | 2515         | Glass             |
| 1434 | T | 25B | 2515         | Window Glass      |
| 1435 | T | 25B | 2515         | Window Glass      |
| 1436 | T | 25B | 2517         | Glass Neck        |
| 1437 | T | 25B | 2517         | Glass             |
| 1438 | T | 25B | 2517         | Glass             |
| 1439 | T | 25B | 2517         | Glass             |
| 1440 | T | 25B | 2517         | Glass             |
| 1441 | T | 25B | 2517         | Glass             |
| 1442 | T | 25B | 2519         | Glass             |
| 1443 | T | 25C | Unstratified | Glass             |
| 1444 | T | 25C | Unstratified | Glass             |
| 1445 | T | 25C | Unstratified | Glass             |
| 1446 | T | 25C | Unstratified | Glass             |
| 1447 | T | 25C | Unstratified | Glass             |
| 1448 | T | 25C | Unstratified | Glass             |
| 1449 | T | 25C | Unstratified | Glass             |
| 1450 | T | 25C | Unstratified | Glass             |
| 1451 | T | 25C | Unstratified | Glass             |
| 1452 | T | 25C | Unstratified | Glass             |
| 1453 | T | 25C | Unstratified | Glass             |
| 1454 | T | 25C | Unstratified | Glass             |
| 1455 | T | 25C | Unstratified | Glass             |
| 1456 | T | 25C | Unstratified | Glass             |

|      |   |     |              |                       |
|------|---|-----|--------------|-----------------------|
| 1457 | T | 25C | Unstratified | Glass                 |
| 1458 | T | 25C | Unstratified | Glass                 |
| 1459 | T | 25C | Unstratified | Glass                 |
| 1460 | T | 25C | Unstratified | Glass                 |
| 1461 | T | 25C | Unstratified | Glass                 |
| 1462 | T | 25C | Unstratified | Glass                 |
| 1463 | E | 26A | 2601         | Glass                 |
| 1464 | E | 26A | 2601         | Glass                 |
| 1465 | E | 26B | 2601         | Glass                 |
| 1466 | E | 26B | 2601         | Glass                 |
| 1467 | E | 26B | 2601         | Glass                 |
| 1468 | T | 27  | 2701         | Glass                 |
| 1469 | T | 27  | 2701         | Glass                 |
| 1470 | T | 27  | 2701         | Glass                 |
| 1471 | T | 27  | 2701         | Glass                 |
| 1472 | T | 27  | 2702         | Glass                 |
| 1473 | T | 27  | 2702         | Glass                 |
| 1474 | T | 27  | 2702         | Glass                 |
| 1475 | T | 28  | 2801         | Glass                 |
| 1476 | T | 28  | 2801         | Glass                 |
| 1477 | T | 28  | 2807         | Glass Stem            |
| 1478 | T | 28  | 2814         | Glass                 |
| 1479 | T | 29  | 2901         | Glass Stopper         |
| 1480 | T | 29  | 2901         | Glass                 |
| 1481 | T | 29  | 2901         | Glass                 |
| 1482 | T | 29  | 2901         | Glass                 |
| 1483 | T | 29  | 2901         | Glass                 |
| 1484 | T | 30H | 3009         | Glass                 |
| 1485 | G | 12  | 1207         | Window Glass          |
| 1486 | G | 12  | 1207         | Window Glass          |
| 1487 | G | 12  | 1207         | Window Glass          |
| 1488 | G | 8   | 801          | Carved Stone?         |
| 1489 | T | 22A | Unstratified | Pottery               |
| 1490 | c | 4   | 401          | Stone Playing Figure? |
| 1491 | G | 17  | 1702         | Plastic Button        |
| 1492 | E | 26B | 2601         | Plastic               |
| 1493 | G | 8   | 801          | Tile                  |
| 1494 | G | 8   | 801          | Tile                  |
| 1495 | G | 8   | 801          | Tile                  |
| 1496 | G | 8   | 801          | Tile                  |
| 1497 | G | 8   | 801          | Tile                  |
| 1498 | G | 8   | 801          | Tile                  |
| 1499 | G | 9B  | 907          | Tile                  |
| 1500 | G | 9B  | 907          | Tile                  |
| 1501 | G | 9B  | 907          | Tile                  |
| 1502 | G | 9B  | 907          | Tile                  |
| 1503 | G | 10  | 1001         | Modern Floor Tile     |
| 1504 | G | 12  | 1206         | Tile                  |
| 1505 | G | 12  | 1207         | Tile                  |
| 1506 | G | 12  | 1207         | Tile                  |
| 1507 | G | 12  | 1207         | Tile                  |
| 1508 | G | 12  | 1207         | Tile                  |
| 1509 | G | 12  | 1207         | Tile                  |
| 1510 | T | 22C | 2215         | Tile                  |
| 1511 | T | 22C | 2215         | Tile                  |
| 1512 | T | 22C | 2215         | Tile                  |
| 1513 | T | 23B | 2312         | Ceramic Ridge Tile    |
| 1514 | T | 23B | 2312         | Ceramic Ridge Tile    |
| 1515 | T | 23B | 2312         | Ceramic Ridge Tile    |



|      |   |     |              |                   |
|------|---|-----|--------------|-------------------|
| 1516 | T | 23C | 2301         | Tile              |
| 1517 | T | 23C | 2301         | Tile              |
| 1518 | T | 23C | 2301         | Tile              |
| 1519 | T | 23C | 2301         | Tile              |
| 1520 | T | 23C | 2301         | Tile              |
| 1521 | T | 23C | 2301         | Tile              |
| 1522 | T | 23B | 2313         | Tile              |
| 1523 | T | 23B | 2313         | Tile              |
| 1524 | T | 23B | 2313         | Tile              |
| 1525 | T | 23B | 2313         | Tile              |
| 1528 | G | 7   | 701          | Stone             |
| 1529 | G | 7   | 701          | Stone             |
| 1530 | G | 7   | 701          | Stone             |
| 1542 | G | 9A  | 931          | Stone             |
| 1543 | G | 9A  | 931          | Stone             |
| 1544 | G | 9A  | 931          | Stone             |
| 1545 | G | 9A  | 931          | Stone             |
| 1546 | G | 9A  | 931          | Stone             |
| 1547 | G | 9A  | 931          | Stone             |
| 1555 | G | 9B  | 907          | Stone With Mortar |
| 1619 | G | 13B | 1301         | Stone/Slate       |
| 1665 | G | 7   | 704          | Stone             |
| 1666 | G | 7   | 707          | Stone             |
| 1667 | G | 7   | 707          | Stone             |
| 1668 | G | 7   | 707          | Stone             |
| 1669 | G | 8   | 803          | Chalk             |
| 1670 | G | 8   | 803          | Chalk             |
| 1671 | G | 8   | 803          | Chalk             |
| 1672 | G | 8   | 803          | Stone             |
| 1673 | G | 8   | 803          | Stone             |
| 1674 | G | 16  | 1602         | Sandstone         |
| 1675 | G | 16  | 1602         | Fishing Weight?   |
| 1676 | G | 16  | 1602         | Sandstone         |
| 1677 | T | 25A | 2504         | Burnt Stone       |
| 1678 | T | 25A | 2504         | Burnt Stone       |
| 1679 | T | 25A | 2504         | Burnt Stone       |
| 1680 | T | 25A | 2504         | Burnt Stone       |
| 1681 | T | 25A | 2504         | Burnt Stone       |
| 1682 | T | 25A | 2504         | Burnt Stone       |
| 1683 | T | 22B | Unstratified | Stone             |

## Metalwork

| Small Find Number | Context      | Trench | Area | Type                   |
|-------------------|--------------|--------|------|------------------------|
| 1684              | 401          | 4      | C    | Coin Fragment          |
| 1685              | 401          | 4      | C    | Metal Object           |
| 1686              | 401          | 4      | C    | Metal Object           |
| 1687              | 401          | 4      | C    | Nail attached to slate |
| 1688              | Unstratified | 7      | G    | Metal Object           |
| 1689              | 704          | 7      | G    | Metal Object           |
| 1690              | 704          | 7      | G    | Metal Object           |
| 1691              | 704          | 7      | G    | Metal Object           |
| 1692              | 704          | 7      | G    | Metal Object           |
| 1693              | 704          | 7      | G    | Metal Object           |
| 1694              | 704          | 7      | G    | Metal Object           |
| 1695              | 707          | 7      | G    | Metal Object           |
| 1696              | 707          | 7      | G    | Metal Object           |
| 1697              | 707          | 7      | G    | Metal Object           |
| 1698              | 707          | 7      | G    | Metal Object           |
| 1699              | 801          | 8      | G    | Metal Object           |
| 1700              | 801          | 8      | G    | Metal Object           |
| 1701              | 931          | 9A     | G    | Nail                   |
| 1702              | 931          | 9A     | G    | Slag                   |
| 1703              | 931          | 9A     | G    | Slag                   |
| 1704              | 931          | 9A     | G    | Slag                   |
| 1705              | 901          | 9B     | G    | Metal Objects          |
| 1706              | 901          | 9B     | G    | Metal Objects          |
| 1707              | 901          | 9B     | G    | Metal Objects          |
| 1708              | 901          | 9B     | G    | Metal Objects          |
| 1709              | 901          | 9B     | G    | Metal Objects          |
| 1710              | 901          | 9B     | G    | Metal Objects          |
| 1711              | 901          | 9B     | G    | Metal Objects          |
| 1712              | 901          | 9B     | G    | Metal Objects          |
| 1713              | 901          | 9B     | G    | Metal Objects          |
| 1714              | 901          | 9B     | G    | Metal Objects          |
| 1715              | 901          | 9B     | G    | Metal Objects          |
| 1716              | 901          | 9B     | G    | Metal Objects          |
| 1717              | 901          | 9B     | G    | Metal Objects          |
| 1718              | 901          | 9B     | G    | Metal Objects          |
| 1719              | 901          | 9B     | G    | Metal Objects          |
| 1720              | 901          | 9B     | G    | Metal Objects          |
| 1721              | 901          | 9B     | G    | Metal Objects          |
| 1722              | 901          | 9B     | G    | Metal Objects          |
| 1723              | 901          | 9B     | G    | Metal Objects          |
| 1724              | 901          | 9B     | G    | Metal Objects          |
| 1725              | 901          | 9B     | G    | Metal Objects          |
| 1726              | 901          | 9B     | G    | Metal Objects          |
| 1727              | 901          | 9B     | G    | Metal Objects          |
| 1728              | 901          | 9B     | G    | Metal Objects          |
| 1729              | 901          | 9B     | G    | Metal Objects          |
| 1730              | 901          | 9B     | G    | Metal Objects          |

|      |              |     |   |               |
|------|--------------|-----|---|---------------|
| 1731 | 901          | 9B  | G | Metal Objects |
| 1732 | 901          | 9B  | G | Metal Objects |
| 1733 | 901          | 9B  | G | Metal Objects |
| 1734 | 901          | 9B  | G | Metal Objects |
| 1735 | 901          | 9B  | G | Metal Objects |
| 1736 | 901          | 9B  | G | Metal Objects |
| 1737 | 901          | 9B  | G | Metal Objects |
| 1738 | 901          | 9B  | G | Metal Objects |
| 1739 | 901          | 9B  | G | Metal Objects |
| 1740 | 901          | 9B  | G | Metal Objects |
| 1741 | 901          | 9B  | G | Metal Objects |
| 1742 | 901          | 9B  | G | Metal Objects |
| 1743 | 901          | 9B  | G | Metal Objects |
| 1744 | 901          | 9B  | G | Metal Objects |
| 1745 | 907          | 9B  | G | Metal Objects |
| 1746 | 907          | 9B  | G | Metal Objects |
| 1747 | 907          | 9B  | G | Metal Objects |
| 1748 | 907          | 9B  | G | Metal Objects |
| 1749 | 911          | 9B  | G | Metal Objects |
| 1750 | 911          | 9B  | G | Metal Objects |
| 1751 | 913          | 9B  | G | Metal Objects |
| 1752 | 916          | 9B  | G | Metal Objects |
| 1753 | 1001         | 10  | G | Metal Handle  |
| 1754 | 1001         | 10  | G | Nail          |
| 1755 | Unstratified | 12  | G | Metal Object  |
| 1756 | 1401         | 14  | G | Metal Object  |
| 1757 | 1401         | 14  | G | Metal Object  |
| 1758 | 1502         | 15  | G | Slag          |
| 1759 | 1601         | 16  | G | Slag          |
| 1760 | 1701         | 17  | G | Metal Ring    |
| 1761 | 2006         | 20  | T | Horseshoe     |
| 1762 | 2003         | 20  | T | Metal Object  |
| 1763 | 2011         | 20  | T | Metal Object  |
| 1764 | 2011         | 20  | T | Metal Object  |
| 1765 | 2101         | 21  | T | Metal Object  |
| 1766 | 2104         | 21  | T | Metal Object  |
| 1767 | 2104         | 21  | T | Metal Object  |
| 1768 | 2104         | 21  | T | Metal Object  |
| 1769 | 2205         | 22A | T | Metal Object  |
| 1770 | Unstratified | 22B | T | Metal Object  |
| 1771 | 2501         | 25A | T | Metal Object  |
| 1772 | 2501         | 25A | T | Metal Object  |
| 1773 | 2501         | 25A | T | Metal Object  |
| 1774 | 2501         | 25A | T | Metal Object  |
| 1775 | 2501         | 25A | T | Metal Object  |
| 1776 | 2503         | 25A | T | Metal Object  |
| 1777 | 2503         | 25A | T | Metal Object  |
| 1778 | 2504         | 25A | T | Metal Object  |
| 1779 | 2504         | 25A | T | Metal Object  |
| 1780 | 2504         | 25A | T | Metal Object  |
| 1781 | 2504         | 25A | T | Metal Object  |
| 1782 | 2504         | 25A | T | Metal Object  |

|      |              |     |   |              |
|------|--------------|-----|---|--------------|
| 1783 | 2504         | 25A | T | Metal Object |
| 1784 | 2504         | 25A | T | Metal Object |
| 1785 | 2507         | 25A | T | Metal Object |
| 1786 | 2507         | 25A | T | Metal Object |
| 1787 | 2507         | 25A | T | Metal Object |
| 1788 | 2507         | 25A | T | Metal Object |
| 1789 | 2507         | 25A | T | Metal Object |
| 1790 | 2507         | 25A | T | Metal Object |
| 1791 | 2507         | 25A | T | Metal Object |
| 1792 | 2507         | 25A | T | Metal Object |
| 1793 | 2507         | 25A | T | Metal Object |
| 1794 | 2507         | 25A | T | Metal Object |
| 1795 | 2508         | 25A | T | Metal Object |
| 1796 | 2508         | 25A | T | Metal Object |
| 1797 | 2508         | 25A | T | Metal Object |
| 1798 | 2508         | 25A | T | Metal Object |
| 1799 | 2508         | 25A | T | Metal Object |
| 1800 | Unstratified | 25A | T | Metal Object |
| 1801 | 2510         | 25B | T | Metal Object |
| 1802 | 2510         | 25B | T | Metal Object |
| 1803 | 2510         | 25B | T | Metal Object |
| 1804 | 2510         | 25B | T | Metal Object |
| 1805 | 2510         | 25B | T | Metal Object |
| 1806 | 2512         | 25B | T | Metal Object |
| 1807 | 2512         | 25B | T | Metal Object |
| 1808 | 2512         | 25B | T | Metal Object |
| 1809 | 2512         | 25B | T | Metal Object |
| 1810 | 2517         | 25B | T | Metal Object |
| 1811 | 2517         | 25B | T | Metal Object |
| 1812 | 2519         | 25B | T | Metal Object |
| 1813 | Unstratified | 25C | T | Metal Object |
| 1814 | Unstratified | 25C | T | Metal Object |
| 1815 | 2601         | 26A | E | Metal Object |
| 1816 | 2601         | 26A | E | Metal Object |
| 1817 | 2601         | 26A | E | Metal Object |
| 1818 | 2601         | 26A | E | Metal Object |
| 1819 | 2601         | 26A | E | Metal Object |
| 1820 | 2601         | 26B | E | Metal Object |
| 1821 | 2601         | 26B | E | Metal Object |
| 1822 | 2601         | 26B | E | Metal Object |
| 1823 | 2601         | 26B | E | Metal Object |
| 1824 | 2611         | 26B | E | Metal Object |
| 1825 | 2701         | 27  | T | Metal Object |
| 1826 | 2701         | 27  | T | Metal Object |
| 1827 | 2701         | 27  | T | Metal Object |
| 1828 | 2701         | 27  | T | Metal Object |
| 1829 | 2701         | 27  | T | Metal Object |
| 1830 | 2701         | 27  | T | Metal Object |
| 1831 | 2701         | 27  | T | Metal Object |
| 1832 | 2701         | 27  | T | Metal Object |
| 1833 | 2701         | 27  | T | Metal Object |
| 1834 | 2702         | 27  | T | Metal Object |

|      |      |    |   |              |
|------|------|----|---|--------------|
| 1835 | 2702 | 27 | T | Metal Object |
| 1836 | 2702 | 27 | T | Metal Object |
| 1837 | 2702 | 27 | T | Metal Object |
| 1838 | 2801 | 28 | T | Metal Object |
| 1839 | 2801 | 28 | T | Metal Object |
| 1840 | 2801 | 28 | T | Metal Object |
| 1841 | 2805 | 28 | T | Metal Object |
| 1842 | 2805 | 28 | T | Metal Object |
| 1843 | 2805 | 28 | T | Metal Object |
| 1844 | 2805 | 28 | T | Metal Object |
| 1845 | 2805 | 28 | T | Metal Object |
| 1846 | 2805 | 28 | T | Metal Object |
| 1847 | 2805 | 28 | T | Metal Object |
| 1848 | 2805 | 28 | T | Metal Object |
| 1849 | 2807 | 28 | T | Metal Object |
| 1850 | 2807 | 28 | T | Metal Object |
| 1851 | 2811 | 28 | T | Metal Object |
| 1852 | 2901 | 29 | D | Nail         |
| 1853 | 3101 | 31 | T | Metal Object |

## Bone

| Context Number | Trench | Area | Type        | Weight (Kg) |
|----------------|--------|------|-------------|-------------|
| 101            | 1      | C    | Animal bone | 0.016       |
| 201            | 2      | C    | Animal bone | 0.03        |
| 502            | 5      | D    | Animal bone | 0.01        |
| 701            | 7      | G    | Animal bone | 0.062       |
| 704            | 7      | G    | Animal bone | 0.296       |
| 705            | 7      | G    | Animal bone | 0.044       |
| 707            | 7      | G    | Animal bone | 0.056       |
| 707            | 7      | G    | Animal bone | 0.03        |
| 707            | 7      | G    | Animal bone | 0.006       |
| 707            | 7      | G    | Animal bone | 0.096       |
| 710            | 7      | G    | Animal bone | 0.014       |
| 712            | 7      | G    | Animal bone | 0.018       |
| Unstratified   | 7      | G    | Animal bone | 0.032       |
| 801            | 8      | G    | Animal bone | 0.012       |
| 803            | 8      | G    | Animal bone | 0.02        |
| 804            | 8      | G    | Animal bone | 0.102       |
| 804            | 8      | G    | Animal bone | 0.03        |
| 804            | 8      | G    | Animal bone | 0.026       |
| 926            | 9A     | G    | Animal bone | 0.106       |
| 926            | 9A     | G    | Animal bone | 0.16        |
| 926            | 9A     | G    | Animal bone | 0.072       |
| 929            | 9A     | G    | Animal bone | 0.062       |
| 930            | 9A     | G    | Animal bone | 0.036       |
| 931            | 9A     | G    | Animal bone | 0.136       |
| 934            | 9A     | G    | Animal bone | 0.02        |
| 935            | 9A     | G    | Animal bone | 0.042       |
| 901            | 9b     | G    | Animal bone | 0.004       |
| 902            | 9B     | G    | Animal bone | 0.034       |
| 907            | 9B     | G    | Animal bone | 0.036       |
| 907            | 9B     | G    | Animal bone | 0.024       |
| 908            | 9B     | G    | Animal bone | 0.154       |
| 910            | 9B     | G    | Animal bone | 0.138       |
| 911            | 9B     | G    | Animal bone | 0.024       |
| 1001           | 10     | G    | Animal bone | 0.008       |
| 1002           | 10     | G    | Animal bone | 0.012       |
| 1002           | 10     | G    | Animal bone | 0.006       |
| 1005           | 10     | G    | Animal bone | 0.01        |
| 1007           | 10     | G    | Animal bone | 0.128       |
| 1007           | 10     | G    | Animal bone | 0.063       |
| 1103           | 11     | G    | Human       | 0.178       |
| 1103           | 11     | G    | Animal bone | 0.01        |
| 1108           | 11     | G    | Animal bone | 0.018       |
| 1201           | 12     | G    | Animal bone | 0.072       |
| 1201           | 12     | G    | Animal bone | 0.234       |
| 1202           | 12     | G    | Animal bone | 0.004       |
| 1203           | 12     | G    | Animal bone | 0.006       |
| 1204           | 12     | G    | Animal bone | 0.216       |
| 1204           | 12     | G    | Animal bone | 0.001       |

|              |     |   |             |       |
|--------------|-----|---|-------------|-------|
| 1206         | 12  | G | Animal bone | 0.058 |
| 1206         | 12  | G | Animal bone | 0.084 |
| 1206         | 12  | G | Animal bone | 0.006 |
| 1206         | 12  | G | Animal bone | 0.006 |
| 1207         | 12  | G | Animal bone | 0.118 |
| 1207         | 12  | G | Animal bone | 0.114 |
| 1210         | 12  | G | Animal bone | 0.02  |
| 1214         | 12  | G | Animal bone | 0.032 |
| 1301         | 13  | G | Animal bone | 0.032 |
| 1303         | 13  | G | Animal bone | 0.064 |
| 1316         | 13  | G | Animal bone | 0.136 |
| 1401         | 14  | G | Animal bone | 0.01  |
| 1404         | 14  | G | Animal bone | 0.04  |
| 1405         | 14  | G | Animal bone | 0.004 |
| 1504         | 15A | G | Animal bone | 0.046 |
| 1506         | 15A | G | Animal bone | 0.244 |
| 1501         | 15B | G | Animal bone | 0.004 |
| 2512         | 15B | G | Animal bone | 0.166 |
| 1601         | 16  | G | Animal bone | 0.002 |
| 1605         | 16  | G | Animal bone | 0     |
| 1605         | 16  | G | Animal bone | 0.012 |
| 1618         | 16  | G | Animal bone | 0.006 |
| 1702         | 17  | G | Animal bone | 0.194 |
| 1703         | 17  | G | Animal bone | 0.062 |
| 1703         | 17  | G | Animal bone | 0.294 |
| 2101         | 21  | T | Animal bone | 0.001 |
| 2104         | 21  | T | Animal bone | 0.001 |
| 2209         | 22A | T | Animal bone | 0.006 |
| 2220         | 22A | T | Animal bone | 0.02  |
| 2203         | 22B | T | Animal bone | 0.006 |
| 2331         | 23A | T | Animal bone | 0.002 |
| 2331         | 23A | T | Animal bone | 0.234 |
| 2313         | 23B | T | Animal bone | 0.53  |
| 2317         | 23B | T | Animal bone | 0.278 |
| 2327         | 23B | T | Animal bone | 0.05  |
| 2501         | 25A | T | Animal bone | 0.004 |
| 2501         | 25A | T | Animal bone | 0.006 |
| 2501         | 25A | T | Animal bone | 0.036 |
| 2503         | 25A | T | Animal bone | 0.004 |
| 2504         | 25A | T | Animal bone | 0.01  |
| 2507         | 25A | T | Animal bone | 0.014 |
| 2507         | 25A | T | Animal bone | 0.008 |
| 2513         | 25A | T | Animal bone | 0.028 |
| Unstratified | 25A | T | Animal bone | 0.028 |
| 2510         | 25B | T | Animal bone | 0.06  |
| 2512         | 25B | T | Animal bone | 0.03  |
| 2513         | 25B | T | Animal bone | 0.01  |
| 2514         | 25B | T | Animal bone | 0.006 |
| 2515         | 25B | T | Animal bone | 0.056 |
| 2515         | 25B | T | Animal bone | 0.136 |
| 2517         | 25B | T | Animal bone | 0.068 |
| 2517         | 25B | T | Animal bone | 0.122 |

|              |     |   |             |       |
|--------------|-----|---|-------------|-------|
| 2519         | 25B | T | Animal bone | 0.006 |
| 2522         | 25B | T | Animal bone | 0.06  |
| Unstratified | 25C | T | Animal bone | 0.074 |
| Unstratified | 25C | T | Animal bone | 0     |
| 2532         | 25C | T | Animal bone | 0.008 |
| 2603         | 26B | E | Animal bone | 0.001 |
| 2610         | 26B | E | Animal bone | 0     |
| 2701         | 27  | T | Animal bone | 0.014 |
| 2801         | 28  | T | Animal bone | 0.114 |
| 2807         | 28  | T | Animal bone | 0.006 |
| 2811         | 28  | T | Animal bone | 0.01  |
| 2811         | 28  | T | Animal bone | 0.006 |
| 2901         | 29  | T | Animal bone | 0.008 |
| 3101         | 31  | T | Animal bone | 0.012 |

## Flint

| Context Number | Trench | Area | Weight (Kg) |
|----------------|--------|------|-------------|
| 102            | 1      | C    | 0.172       |
| 401            | 4      | C    | 0.003       |
| 502            | 5      | D    | 0.530       |
| 701            | 7      | G    | 0.588       |
| 704            | 7      | G    | 0.692       |
| 705            | 7      | G    | 0.516       |
| 707            | 7      | G    | 0.554       |
| 710            | 7      | G    | 0.864       |
| 714            | 7      | G    | 0.344       |
| 801            | 8      | G    | 0.172       |
| 803            | 8      | G    | 0.460       |
| 804            | 8      | G    | 0.900       |
| 806            | 8      | G    | 0.846       |
| 926            | 9A     | G    | 0.004       |
| 931            | 9A     | G    | 1.068       |
| 901            | 9B     | G    | 0.506       |
| 907            | 9B     | G    | 0.692       |
| 908            | 9B     | G    | 0.232       |
| 910            | 9B     | G    | 0.146       |
| 1001           | 10     | G    | 0.004       |
| 1002           | 10     | G    | 0.076       |
| 1004           | 10     | G    | 0.544       |
| 1005           | 10     | G    | 0.084       |
| 1007           | 10     | G    | 1.361       |
| 1103           | 11     | G    | 0.010       |
| 1206           | 12     | G    | 0.812       |
| 1207           | 12     | G    | 0.120       |
| 1400           | 14     | G    | 0.826       |
| 1401           | 14     | G    | 0.296       |
| 1402           | 14     | G    | 0.484       |



|      |     |   |       |
|------|-----|---|-------|
| 1404 | 14  | G | 0.008 |
| 1405 | 14  | G | 0.162 |
| 1601 | 16  | G | 0.636 |
| 1602 | 16  | G | 0.624 |
| 1603 | 16  | G | 0.372 |
| 1605 | 16  | G | 0.714 |
| 1608 | 16  | G | 2.154 |
| 1612 | 16  | G | 0.364 |
| 1615 | 16  | G | 1.220 |
| 1618 | 16  | G | 0.156 |
| 2001 | 20  | T | 0.024 |
| 2003 | 20  | T | 0.170 |
| 2004 | 20  | T | 0.202 |
| 2006 | 20  | T | 0.018 |
| 2008 | 20  | T | 0.082 |
| 2010 | 20  | T | 0.082 |
| 2011 | 20  | T | 0.414 |
| 2101 | 21  | T | 0.009 |
| 2104 | 21  | T | 0.086 |
| 2205 | 22A | T | 0.030 |
| 2209 | 22A | T | 0.028 |
| 2212 | 22A | T | 0.054 |
| 2215 | 22C | T | 0.188 |
| 2219 | 22C | T | 0.310 |
| 2312 | 23A | T | 0.010 |
| 2501 | 25A | T | 0.068 |
| 2507 | 25A | T | 0.010 |
| 2507 | 25B | T | 0.118 |
| 2510 | 25B | T | 0.066 |
| 2512 | 25B | T | 0.078 |
| 2515 | 25B | T | 0.078 |
| 2517 | 25B | T | 0.312 |
| 2519 | 25B | T | 0.228 |
| 2522 | 25B | T | 0.056 |
| 2601 | 26A | E | 0.034 |
| 2607 | 26A | E | 0.010 |
| 2601 | 26B | E | 1.104 |
| 2603 | 26B | E | 0.490 |
| 2610 | 26B | E | 0.028 |
| 2611 | 26B | E | 0.036 |
| 2613 | 26B | E | 0.066 |
| 2701 | 27  | T | 0.010 |
| 2708 | 27  | T | 0.002 |
| 2801 | 28  | T | 0.038 |
| 2805 | 28  | T | 0.026 |
| 2807 | 28  | T | 0.016 |
| 2811 | 28  | T | 0.090 |
| 2814 | 28  | T | 0.014 |
| 3009 | 30H | T | 0.016 |
| 3101 | 31  | T | 0.006 |

## Brick

| Small find no. | Trench | Context | Complete | Length (mm) | Width (mm) | Depth (mm) |
|----------------|--------|---------|----------|-------------|------------|------------|
| 0001           | 17     | 1705    | X        | 105         | 112        | 55         |
| 0002           | 17     | 1705    | X        | 111         | 92         | 54         |
| 0003           | 17     | 1705    | X        | 89          | 110        | 53         |
| 0004           | 17     | 1705    | X        | 110         | 102        | 60         |
| 0005           | 17     | 1705    | X        | 153         | 75         | 49         |
| 0006           | 17     | 1705    | X        | 114         | 101        | 57         |
| 0007           | 17     | 1705    | X        | 115         | 63         | 55         |
| 0008           | 17     | 1705    | X        | 73          | 74         | 58         |
| 0009           | 17     | 1705    | X        | 80          | 70         | 55         |
| 0010           | 17     | 1705    | X        | 80          | 107        | 58         |
| 0011           | 17     | 1705    | X        | 137         | 73         | 57         |
| 0012           | 17     | 1705    | X        | 164         | 122        | 72         |
| 0013           | 17     | 1705    | X        | 123         | 111        | 63         |
| 0014           | 17     | 1705    | X        | 79          | 113        | 59         |
| 0015           | 17     | 1705    | X        | 90          | 85         | 58         |
| 0016           | 17     | 1705    | X        | 100         | 110        | 59         |
| 0017           | 17     | 1705    | X        | 170         | 106        | 63         |
| 0018           | 17     | 1705    | X        | 118         | 106        | 60         |
| 0019           | 17     | 1705    | X        | 93          | 107        | 57         |
| 0020           | 17     | 1705    | X        | 97          | 106        | 65         |
| 0021           | 17     | 1705    | X        | 95          | 91         | 51         |
| 0022           | 17     | 1705    | X        | 114         | 70         | 53         |
| 0023           | 17     | 1705    | X        | 121         | 64         | 59         |
| 0024           | 17     | 1705    | X        | 170         | 107        | 68         |
| 0025           | 17     | 1705    | X        | 108         | 105        | 59         |
| 0026           | 17     | 1705    | X        | 85          | 105        | 56         |
| 0027           | 17     | 1705    | X        | 88          | 88         | 55         |
| 0028           | 17     | 1705    | X        | 104         | 103        | 58         |
| 0029           | 17     | 1705    | X        | 116         | 105        | 59         |
| 0030           | 17     | 1705    | X        | 135         | 103        | 53         |
| 0031           | 17     | 1705    | X        | 95          | 105        | 50         |
| 0032           | 17     | 1705    | X        | 78          | 97         | 65         |
| 0033           | 17     | 1705    | X        | 86          | 110        | 59         |
| 0034           | 17     | 1705    | X        | 144         | 84         | 58         |
| 0035           | 17     | 1705    | X        | 58          | 113        | 62         |
| 0036           | 17     | 1705    | X        | 101         | 90         | 59         |
| 0037           | 17     | 1705    | X        | 66          | 110        | 60         |
| 0038           | 17     | 1705    | P        | 185         | 104        | 57         |
| 0039           | 17     | 1705    | X        | 90          | 107        | 62         |
| 0040           | 17     | 1705    | X        | 95          | 107        | 60         |
| 0041           | 17     | 1705    | X        | 151         | 104        | 63         |
| 0042           | 17     | 1705    | P        | 185         | 108        | 62         |
| 0043           | 17     | 1705    | X        | 93          | 82         | 54         |
| 0044           | 17     | 1705    | X        | 105         | 103        | 63         |
| 0045           | 17     | 1705    | X        | 134         | 107        | 55         |
| 0046           | 17     | 1705    | X        | 131         | 106        | 60         |
| 0047           | 17     | 1705    | X        | 93          | 103        | 42         |

|      |    |      |   |     |     |    |
|------|----|------|---|-----|-----|----|
| 0048 | 17 | 1705 | X | 67  | 97  | 52 |
| 0049 | 17 | 1705 | X | 109 | 109 | 61 |
| 0050 | 17 | 1705 | X | 104 | 107 | 62 |
| 0051 | 17 | 1705 | X | 150 | 108 | 63 |
| 0052 | 17 | 1705 | X | 185 | 105 | 56 |
| 0053 | 17 | 1705 | X | 109 | 106 | 58 |
| 0054 | 17 | 1705 | X | 133 | 103 | 68 |
| 0055 | 17 | 1705 | X | 104 | 105 | 57 |
| 0056 | 17 | 1705 | X | 144 | 104 | 71 |
| 0057 | 17 | 1705 | X | 92  | 71  | 62 |
| 0058 | 17 | 1705 | X | 99  | 97  | 61 |
| 0059 | 17 | 1705 | X | 138 | 108 | 59 |
| 0060 | 17 | 1705 | P | 188 | 110 | 74 |
| 1523 | 2  | 201  | X | 36  | 24  | 6  |
| 1524 | 2  | 201  | X | 23  | 13  | 9  |
| 1525 | 2  | 201  | X | 18  | 14  | 7  |
| 1526 | 2  | 201  | X | 13  | 10  | 4  |
| 1527 | 2  | 201  | X | 42  | 39  | 13 |
| 1531 | 7  | 701  | X | 113 | 78  | 61 |
| 1532 | 7  | 701  | X | 66  | 50  | 52 |
| 1534 | 9A | 926  | X | 56  | 32  | 30 |
| 1535 | 9A | 926  | X | 64  | 34  | 26 |
| 1536 | 9A | 926  | X | 50  | 35  | 30 |
| 1537 | 9A | 926  | X | 41  | 27  | 13 |
| 1538 | 9A | 926  | X | 40  | 19  | 13 |
| 1539 | 9A | 926  | X | 27  | 18  | 11 |
| 1540 | 9A | 926  | X | 28  | 18  | 16 |
| 1541 | 9A | 926  | X | 12  | 11  | 15 |
| 1548 | 9A | 931  | X | 48  | 31  | 21 |
| 1549 | 9A | 931  | X | 37  | 21  | 14 |
| 1550 | 9A | 931  | X | 24  | 18  | 8  |
| 1551 | 9A | 931  | X | 21  | 13  | 3  |
| 1552 | 9A | 931  | X | 13  | 10  | 4  |
| 1553 | 9A | 931  | X | 10  | 7   | 6  |
| 1554 | 9A | 931  | X | 11  | 8   | 3  |

## Slate

| Small Find No. | Trench | Context | Complete | Tapered | Distance of nail hole to top of slate (mm) | Diameter of nail hole (mm) | Width at top (mm) | Width at bottom (mm) | Length (mm) | Thickness (mm) | Other comments (tapered edges, mortar, nail present, etc.) |
|----------------|--------|---------|----------|---------|--|----------------------------|-------------------|----------------------|-------------|----------------|--|
| 0061           | 12     | 1205    | X        | N/A     | 9  | 7                          | 127               | 127                  | 183         | 9              | Mortar present, nail hole broken                           |
| 0062           | 12     | 1205    | X        | X       | 18   | 7                          | 134               | 149                  | 170         | 11             | Small amount of mortar, nail hole in top left              |
| 0063           | 12     | 1205    | X        | N/A     | 10   | 8                          | 79                | 92                   | 92          | 9              | Small amount of mortar                                     |
| 0064           | 12     | 1205    | X        | N/A     | N/A  | 9                          | 75                | 108                  | 159         | 13             | Mortar present, nail hole broken                           |
| 0065           | 12     | 1205    | X        | X       | 8  | 7                          | 114               | 113                  | 160         | 15             | Mortar present, nail hole in top right                     |
| 0066           | 12     | 1205    | X        | X       | N/A  | 6                          | 100               | 103                  | 152         | 9              | Mortar present, nail hole in top right                     |
| 0067           | 12     | 1205    | X        | X       | 19   | 8                          | 94                | 102                  | 163         | 11             | Mortar present, nail hole broken                           |
| 0068           | 12     | 1205    | X        | N/A     | N/A  | 9                          | 71                | 39                   | 97          | 8              | Mortar present, nail hole broken                           |
| 0069           | 12     | 1205    | X        | N/A     | 7  | 4                          | 47                | 45                   | 63          | 6              |  |
| 0070           | 12     | 1205    | X        | N/A     | N/A  | 5                          | 58                | 67                   | 179         | 6              | Mortar present, nail hole broken                           |
| 0071           | 12     | 1205    | X        | N/A     | 17   | 9                          | 79                | 80                   | 173         | 13             |  |
| 0072           | 12     | 1205    | X        | P       | N/A  | 7                          | 41                | 76                   | 195         | 7              | Mortar present, nail hole broken, tapered edge             |
| 0073           | 12     | 1205    | X        | X       | 17   | 6                          | 129               | 134                  | 172         | 13             | Mortar present   |
| 0074           | 12     | 1205    | X        | X       | 11   | 7                          | 113               | 150                  | 164         | 11             | Mortar present   |
| 0075           | 12     | 1205    | X        | X       | 20   | 8                          | 155               | 162                  | 173         | 10             | Mortar present, central nail hole                          |
| 0076           | 12     | 1205    | X        | X       | N/A  | 4                          | 116               | 113                  | 176         | 15             | Mortar present, nail hole broken                           |
| 0077           | 12     | 1205    | X        | N/A     | N/A  | 8                          | 59                | 92                   | 138         | 12             | Mortar present, nail hole broken                           |
| 0078           | 12     | 1205    | X        | N/A     | N/A  | N/A                        | 105               | 140                  | 152         | 13             | Mortar present, nail hole broken                           |
| 0079           | 12     | 1205    | X        | N/A     | N/A  | 9                          | 86                | 95                   | 159         | 11             | Mortar present, nail hole broken, potential second hole    |
| 0080           | 12     | 1205    | X        | N/A     | N/A  | N/A                        | 123               | 85                   | 160         | 12             | Nail hole broken   |
| 0081           | 12     | 1205    | X        | N/A     | N/A  | 5                          | 85                | 69                   | 121         | 7              | Mortar present, nail hole broken                           |
| 0082           | 12     | 1205    | X        | X       | 10   | 6                          | 70                | 100                  | 162         | 8              | Mortar present, nail hole in top left                      |
| 0083           | 12     | 1205    | X        | X       | 21   | 12                         | 87                | 99                   | 172         | 12             | Mortar present, nail hole in top left                      |
| 0084           | 12     | 1205    | X        | P       | 12   | 10                         | 84                | 140                  | 335         | 19             | Mortar present, nail hole broken                           |
| 0085           | 12     | 1205    | X        | N/A     | 9  | 8                          | 61                | 112                  | 162         | 9              | Mortar present, central nail hole                          |
| 0086           | 12     | 1205    | X        | X       | 14   | 7                          | 84                | 88                   | 165         | 15             | Mortar present, central nail hole                          |
| 0087           | 12     | 1205    | X        | N/A     | 23   | 5                          | 123               | 145                  | 216         | 12             | Mortar present, central nail hole                          |
| 0088           | 12     | 1205    | P        | X       | 9  | 8                          | 92                | 117                  | 164         | 16             | Mortar present, central nail hole                          |
| 0089           | 12     | 1205    | X        | X       | 23   | 5                          | 75                | 88                   | 176         | 12             | Mortar present, central nail hole                          |
| 0090           | 12     | 1205    | X        | X       | 13   | 8                          | 60                | 72                   | 164         | 10             | Mortar present, central nail hole                          |

|      |    |      |   |     |     |     |     |     |     |    |   |
|------|----|------|---|-----|-----|-----|-----|-----|-----|----|---|
| 0091 | 12 | 1205 | X | X   | N/A | 6   | 90  | 93  | 162 | 11 | Mortar present, central nail hole broken    |
| 0092 | 12 | 1205 | X | N/A | N/A | 7   | 110 | 117 | 162 | 13 | Mortar present, central nail hole broken    |
| 0093 | 12 | 1205 | X | N/A | N/A | N/A | 100 | 102 | 70  | 4  | Mortar present, nail hole broken            |
| 0094 | 12 | 1205 | X | N/A | N/A | 8   | 100 | 114 | 77  | 8  | Mortar present, nail hole broken            |
| 0095 | 12 | 1205 | X | N/A | 12  | 8   | 60  | 76  | 165 | 13 | Mortar present                              |
| 0096 | 12 | 1205 | X | N/A | N/A | 7   | 48  | 47  | 99  | 10 | Nail hole broken                            |
| 0097 | 12 | 1205 | X | X   | 24  | 7   | 135 | 150 | 348 | 18 | Mortar present, central nail hole           |
| 0098 | 12 | 1205 | X | P   | N/A | 4   | 85  | 121 | 340 | 18 | Mortar present, nail hole broken            |
| 0099 | 12 | 1205 | X | X   | 17  | 14  | 110 | 110 | 340 | 16 | Mortar present, nail hole in top right      |
| 0100 | 12 | 1205 | X | N/A | N/A | N/A | 116 | 133 | 241 | 14 | Mortar present, no nail hole                |
| 0101 | 12 | 1205 | X | X   | N/A | N/A | 115 | 144 | 282 | 12 | Mortar present, no nail hole                |
| 0102 | 12 | 1205 | X | X   | N/A | N/A | 89  | 91  | 126 | 9  | No nail hole, no mortar                     |
| 0103 | 12 | 1205 | X | N/A | N/A | N/A | 85  | 120 | 142 | 8  | No nail hole, no mortar                     |
| 0104 | 12 | 1205 | X | N/A | N/A | N/A | 62  | 82  | 145 | 11 | No nail hole, no mortar                     |
| 0105 | 12 | 1205 | X | N/A | N/A | N/A | 90  | 91  | 42  | 13 | No nail hole, no mortar                     |
| 0106 | 12 | 1205 | X | N/A | N/A | N/A | 94  | 112 | 128 | 14 | No nail hole, no mortar                     |
| 0107 | 12 | 1205 | X | N/A | N/A | N/A | 96  | 115 | 218 | 13 | No nail hole, no mortar                     |
| 0108 | 12 | 1205 | X | N/A | N/A | N/A | 74  | 56  | 113 | 14 | No nail hole, no mortar                     |
| 0109 | 12 | 1205 | X | N/A | N/A | N/A | 96  | 81  | 181 | 19 | No nail hole, no mortar                     |
| 0110 | 12 | 1205 | X | N/A | N/A | N/A | 50  | 70  | 125 | 11 | No nail hole, no mortar                     |
| 0111 | 12 | 1205 | X | N/A | N/A | N/A | 110 | 75  | 187 | 12 | No nail hole, no mortar                     |
| 0112 | 12 | 1205 | X | N/A | N/A | N/A | 64  | 84  | 152 | 11 | No nail hole, no mortar                     |
| 0113 | 12 | 1205 | P | X   | 14  | 8   | 120 | 131 | 194 | 11 | Mortar present, central nail hole           |
| 0114 | 12 | 1205 | X | X   | N/A | N/A | 115 | 123 | 155 | 12 | Mortar present, no nail hole                |
| 0115 | 12 | 1205 | X | N/A | N/A | 10  | 52  | 104 | 163 | 12 | Mortar present, broken nail hole            |
| 0116 | 12 | 1205 | P | X   | 14  | 9   | 100 | 106 | 171 | 15 | Mortar present, hole to the right           |
| 0117 | 12 | 1205 | X | X   | N/A | 8   | 96  | 111 | 163 | 15 | Mortar present, broken nail hole, top right |
| 0118 | 12 | 1205 | X | X   | N/A | 7   | 95  | 109 | 165 | 12 | Mortar present, broken nail hole, top right |
| 0119 | 12 | 1205 | X | X   | N/A | 9   | 110 | 123 | 176 | 13 | Mortar present, broken nail hole, central   |
| 0120 | 12 | 1205 | X | N/A | N/A | 6   | 133 | 216 | 230 | 13 | Mortar present, broken nail hole            |
| 0121 | 12 | 1205 | X | X   | N/A | N/A | 126 | 134 | 214 | 13 | Mortar present, no hole present             |
| 0122 | 12 | 1205 | X | X   | N/A | 6   | 82  | 121 | 158 | 14 | Mortar present, broken nail hole            |
| 0123 | 12 | 1205 | X | X   | N/A | 8   | 113 | 120 | 164 | 16 | Mortar present, broken nail hole, central   |
| 0124 | 12 | 1205 | X | X   | N/A | N/A | 166 | 170 | 147 | 17 | Mortar present, no nail hole                |
| 0125 | 12 | 1205 | X | X   | N/A | N/A | 90  | 101 | 156 | 12 | Mortar present, broken nail hole            |
| 0126 | 12 | 1205 | X | N/A | N/A | N/A | 56  | 79  | 176 | 10 | Mortar present, no nail hole                |

|      |    |      |   |     |     |     |     |     |     |    |  |
|------|----|------|---|-----|-----|-----|-----|-----|-----|----|--|
| 0127 | 12 | 1205 | X | X   | N/A | N/A | 75  | 103 | 176 | 13 | Mortar present, no nail hole               |
| 0128 | 12 | 1205 | X | N/A | N/A | N/A | 170 | 130 | 146 | 11 | Mortar present, no nail hole               |
| 0129 | 12 | 1205 | X | N/A | N/A | N/A | 93  | 76  | 125 | 11 | No nail hole, some evidence of pitting     |
| 0130 | 12 | 1205 | X | N/A | N/A | N/A | 86  | 56  | 105 | 10 | Mortar present, no nail hole               |
| 0131 | 12 | 1205 | X | N/A | N/A | N/A | 59  | 93  | 135 | 10 | No mortar, no nail hole                    |
| 0132 | 12 | 1205 | X | N/A | N/A | N/A | 40  | 50  | 108 | 9  | No mortar, no nail hole                    |
| 0133 | 12 | 1205 | X | N/A | N/A | N/A | 46  | 69  | 120 | 14 | No mortar, no nail hole                    |
| 0134 | 12 | 1205 | P | X   | 14  | 7   | 140 | 174 | 301 | 16 | Mortar present, central nail hole          |
| 0135 | 12 | 1205 | X | P   | N/A | 11  | 182 | 140 | 271 | 21 | Mortar present, broken nail hole           |
| 0136 | 12 | 1205 | P | P   | 18  | 10  | 79  | 163 | 263 | 18 | Mortar present, central nail hole          |
| 0137 | 12 | 1205 | X | X   | 10  | 5   | 89  | 80  | 164 | 10 | Mortar present, nail hole top right        |
| 0138 | 12 | 1205 | X | X   | N/A | N/A | 95  | 94  | 103 | 12 | Mortar present, possible broken nail hole  |
| 0139 | 12 | 1205 | X | N/A | N/A | N/A | 24  | 90  | 135 | 10 | Mortar present, no nail hole               |
| 0140 | 12 | 1205 | X | N/A | N/A | N/A | 50  | 64  | 130 | 6  | Mortar present, no nail hole               |
| 0141 | 12 | 1205 | X | N/A | 8   | 8   | 89  | 110 | 165 | 14 | Mortar present, central nail hole          |
| 0142 | 12 | 1205 | X | X   | 7   | 7   | 112 | 57  | 152 | 8  | Mortar present, central nail hole          |
| 0143 | 12 | 1205 | X | X   | 9   | 7   | 91  | 77  | 151 | 13 | Mortar present, nail hole top left         |
| 0144 | 12 | 1205 | X | X   | N/A | 6   | 57  | 56  | 151 | 9  | Mortar present, nail hole top left, broken |
| 0145 | 12 | 1205 | X | N/A | N/A | N/A | 36  | 25  | 80  | 8  | Mortar present, no nail hole               |
| 0146 | 12 | 1205 | X | N/A | 11  | 8   | 51  | 63  | 63  | 13 |  |
| 0147 | 12 | 1205 | X | N/A | N/A | N/A | 54  | 63  | 100 | 12 | Mortar present                             |
| 0148 | 12 | 1204 | P | X   | 4   | 6   | 113 | 115 | 174 | 16 | Mortar present, nail hole top right        |
| 0149 | 12 | 1204 | P | X   | 20  | 8   | 78  | 89  | 171 | 13 | Mortar present, nail hole central          |
| 0150 | 12 | 1204 | X | N/A | 26  | N/A | 93  | 121 | 166 | 15 | Mortar present, nail hole broken           |
| 0151 | 12 | 1204 | P | X   | 12  | 8   | 80  | 91  | 154 | 12 | Mortar present, nail hole central          |
| 0152 | 12 | 1204 | X | X   | 18  | 6   | 152 | 154 | 169 | 13 | Mortar present, nail hole top left         |
| 0153 | 12 | 1204 | X | X   | N/A | 8   | 144 | 159 | 179 | 11 | Mortar present, nail hole top left, broken |
| 0154 | 12 | 1204 | X | N/A | 7   | 7   | 128 | 155 | 162 | 11 | Mortar present, nail hole top left         |
| 0155 | 12 | 1204 | P | P   | 9   | 8   | 55  | 91  | 144 | 21 | Mortar present, nail hole top left         |
| 0156 | 12 | 1204 | X | X   | N/A | N/A | 76  | 96  | 157 | 14 | Mortar present, nail hole broken           |
| 0157 | 12 | 1204 | X | X   | N/A | 8   | 97  | 100 | 159 | 12 | Mortar present, nail hole central, broken  |
| 0158 | 12 | 1204 | X | X   | N/A | 8   | 96  | 119 | 205 | 9  | Mortar present, nail hole central, broken  |
| 0159 | 12 | 1204 | X | N/A | 21  | 7   | 122 | 82  | 179 | 8  | Mortar present                             |
| 0160 | 12 | 1204 | X | N/A | N/A | N/A | 75  | 75  | 100 | 9  | No mortar, nail hole broken                |
| 0161 | 12 | 1204 | X | X   | 21  | 11  | 149 | 92  | 246 | 15 | No mortar, nail hole top right             |
| 0162 | 12 | 1204 | X | X   | N/A | 8   | 123 | 85  | 140 | 12 | No mortar, nail hole central, broken       |

|      |    |      |   |     |       |      |     |     |     |    |   |
|------|----|------|---|-----|-------|------|-----|-----|-----|----|---|
| 0163 | 12 | 1204 | X | X   | N/A   | N/A  | 99  | 100 | 147 | 11 | No mortar, no hole                              |
| 0164 | 12 | 1204 | X | N/A | N/A   | N/A  | 82  | 106 | 113 | 9  | No mortar, no hole                              |
| 0165 | 12 | 1204 | X | X   | N/A   | N/A  | 75  | 100 | 157 | 7  | No mortar, nail hole central, broken            |
| 0166 | 12 | 1204 | X | N/A | N/A   | N/A  | 105 | 190 | 194 | 8  | No mortar, no nail hole                         |
| 0167 | 12 | 1204 | X | N/A | N/A   | N/A  | 136 | 128 | 171 | 12 | No mortar, no nail hole                         |
| 0168 | 12 | 1204 | X | N/A | N/A   | N/A  | 70  | 86  | 130 | 12 | No mortar, no nail hole                         |
| 0169 | 12 | 1204 | P | X   | 18    | 9    | 92  | 158 | 227 | 16 | No mortar, nail hole top right                  |
| 0170 | 12 | 1204 | P | X   | 14    | 7    | 101 | 98  | 189 | 15 | No mortar, nail hole top left                   |
| 0171 | 12 | 1204 | X | X   | N/A   | N/A  | 128 | 147 | 208 | 12 | No mortar, nail hole top left, broken           |
| 0172 | 12 | 1204 | X | X   | 14    | 7    | 79  | 103 | 134 | 15 | No mortar, nail hole top right                  |
| 0173 | 12 | 1204 | X | N/A | N/A   | 10   | 73  | 60  | 95  | 9  | No mortar, nail hole broken                     |
| 0174 | 12 | 1204 | X | N/A | N/A   | N/A  | 52  | 61  | 73  | 9  | No mortar, nail hole broken                     |
| 0175 | 12 | 1204 | X | N/A | 9     | 10   | 41  | 52  | 44  | 8  | No mortar                                       |
| 0176 | 12 | 1204 | P | P   | 10    | 9    | 108 | 139 | 335 | 15 | Mortar present, nail hole central               |
| 0177 | 12 | 1204 | X | X   | 14    | 11   | 148 | 180 | 281 | 10 | Mortar present, nail hole central, broken       |
| 0178 | 12 | 1204 | X | N/A | N/A   | N/A  | 144 | 193 | 231 | 15 | Mortar present                                  |
| 0179 | 12 | 1204 | X | P   | N/A   | 8    | 134 | 182 | 330 | 14 | Mortar present, nail hole central, broken       |
| 0180 | 12 | 1204 | X | X   | N/A   | 8    | 64  | 58  | 146 | 6  | Mortar present, charcoal in the mortar          |
| 0181 | 12 | 1204 | X | X   | 18    | 7    | 104 | 123 | 161 | 13 | Mortar present, nail hole central               |
| 0182 | 12 | 1204 | X | X   | 80    | 9    | 97  | 224 | 175 | 12 | Mortar present, nail hole central, nail present |
| 0183 | 12 | 1204 | X | N/A | N/A   | N/A  | 108 | 88  | 169 | 11 | Mortar present, no nail hole                    |
| 0184 | 12 | 1204 | X | N/A | N/A   | N/A  | 95  | 94  | 125 | 12 | No mortar, no nail hole                         |
| 0185 | 12 | 1204 | P | X   | 8     | 8    | 80  | 126 | 160 | 10 | Mortar present, nail hole top left              |
| 0186 | 12 | 1204 | P | X   | 14    | 8    | 102 | 120 | 167 | 12 | Mortar present, nail hole top left              |
| 0187 | 12 | 1204 | X | N/A | N/A   | 12   | 84  | 35  | 144 | 3  | No mortar, broken nail hole                     |
| 0188 | 12 | 1204 | X | N/A | 21    | 12   | 91  | 41  | 162 | 5  | No mortar, nail hole top left                   |
| 0189 | 12 | 1204 | X | N/A | 9     | 6    | 66  | 63  | 152 | 11 | Mortar present, nail hole top left              |
| 0190 | 12 | 1204 | X | N/A | N/A   | N/A  | 53  | 33  | 100 | 3  | Mortar present                                  |
| 0191 | 12 | 1204 | P | X   | 24    | 17   | 110 | 105 | 186 | 9  | No mortar, nail hole central                    |
| 0192 | 12 | 1204 | X | X   | N/A   | N/A  | 132 | 94  | 167 | 11 | Mortar present, nail hole top right, broken     |
| 0193 | 12 | 1204 | X | X   | N/A   | N/A  | 124 | 122 | 160 | 14 | Mortar present, nail hole top right, broken     |
| 0194 | 12 | 1204 | P | X   | 20    | 9    | 75  | 80  | 123 | 11 | No mortar, nail hole top left                   |
| 0195 | 12 | 1204 | P | X   | 16    | 8    | 77  | 89  | 169 | 17 | Mortar present, nail hole central               |
| 0196 | 12 | 1204 | X | X   | 20/11 | 17/7 | 108 | 92  | 115 | 10 | No mortar, two nail holes                       |
| 0197 | 12 | 1204 | X | X   | 12    | 7    | 62  | 83  | 126 | 8  | Mortar present, nail hole central               |
| 0198 | 12 | 1204 | X | N/A | N/A   | N/A  | 58  | 110 | 200 | 12 | Mortar present, no nail hole                    |

|      |    |      |   |     |     |     |     |     |     |    |   |
|------|----|------|---|-----|-----|-----|-----|-----|-----|----|---|
| 0199 | 12 | 1204 | X | N/A | N/A | N/A | 52  | 85  | 184 | 7  | Mortar present, no nail hole                |
| 0200 | 12 | 1204 | X | N/A | N/A | N/A | 79  | 98  | 138 | 15 | Mortar present, no nail hole                |
| 0201 | 12 | 1204 | X | N/A | N/A | N/A | 55  | 54  | 139 | 9  | Mortar present, no nail hole                |
| 0202 | 12 | 1204 | X | N/A | N/A | N/A | 68  | 132 | 165 | 15 | Mortar present, no nail hole                |
| 0203 | 12 | 1204 | X | N/A | N/A | N/A | 95  | 74  | 116 | 15 | No mortar, no nail hole                     |
| 0204 | 12 | 1204 | X | N/A | N/A | N/A | 34  | 67  | 98  | 3  | Mortar present, no nail hole                |
| 0205 | 12 | 1204 | X | N/A | N/A | N/A | 104 | 103 | 157 | 9  | No mortar, no nail hole                     |
| 0206 | 12 | 1204 | X | N/A | 9   | 10  | 93  | 114 | 89  | 9  | Mortar present, nail hole top left          |
| 0207 | 12 | 1204 | P | X   | 16  | 7   | 81  | 99  | 192 | 12 | Mortar present, nail hole central           |
| 0208 | 12 | 1204 | X | X   | N/A | N/A | 96  | 131 | 184 | 10 | Mortar present, nail hole top left, broken  |
| 0209 | 12 | 1204 | X | X   | N/A | N/A | 72  | 45  | 163 | 7  | Mortar present, nail hole central, broken   |
| 0210 | 12 | 1204 | X | X   | N/A | N/A | 74  | 82  | 118 | 10 | Mortar present, nail hole central, broken   |
| 0211 | 12 | 1204 | P | X   | 16  | 6   | 67  | 92  | 185 | 10 | Mortar present, nail hole top left          |
| 0212 | 12 | 1204 | P | X   | 15  | 7   | 104 | 114 | 169 | 14 | Mortar present, nail hole central           |
| 0213 | 12 | 1204 | X | X   | 16  | 7   | 92  | 98  | 102 | 7  | Mortar present, nail hole top right         |
| 0214 | 12 | 1204 | X | X   | 13  | 10  | 74  | 73  | 112 | 9  | Mortar present, nail hole central           |
| 0215 | 12 | 1204 | P | X   | 17  | 8   | 87  | 111 | 162 | 7  | Mortar present, nail hole top left          |
| 0216 | 12 | 1204 | X | X   | N/A | N/A | 87  | 112 | 161 | 5  | Mortar present, nail hole top right, broken |
| 0217 | 12 | 1204 | X | N/A | 11  | 8   | 122 | 33  | 126 | 11 | Mortar present, nail hole central           |
| 0218 | 12 | 1204 | P | X   | 13  | 7   | 60  | 72  | 131 | 6  | Mortar present, nail hole central           |
| 0219 | 12 | 1204 | P | X   | 12  | 8   | 54  | 80  | 169 | 10 | Mortar present, nail hole top right         |
| 0220 | 12 | 1204 | X | N/A | 20  | 7   | 41  | 37  | 67  | 7  | No mortar, nail hole central                |
| 0221 | 12 | 1204 | X | X   | N/A | N/A | 82  | 93  | 113 | 5  | Mortar present, nail hole top left, broken  |
| 0222 | 12 | 1204 | P | X   | 11  | 9   | 66  | 86  | 187 | 10 | Mortar present, nail hole central           |
| 0223 | 12 | 1204 | X | N/A | N/A | N/A | 101 | 102 | 161 | 17 | No mortar, no nail hole, some pitting       |
| 0224 | 12 | 1204 | X | X   | 15  | 6   | 66  | 92  | 153 | 12 | Mortar present, nail hole top right         |
| 0225 | 12 | 1204 | X | X   | N/A | N/A | 120 | 116 | 163 | 10 | Mortar present, no nail hole                |
| 0226 | 12 | 1204 | P | X   | 17  | 7   | 101 | 111 | 187 | 10 | Mortar present, nail hole central           |
| 0227 | 12 | 1204 | P | X   | 11  | 6   | 122 | 131 | 167 | 15 | Mortar present, nail hole central           |
| 0228 | 12 | 1204 | X | X   | 18  | 9   | 134 | 150 | 235 | 11 | Mortar present, nail hole central           |
| 0229 | 12 | 1204 | X | X   | N/A | N/A | 117 | 164 | 285 | 10 | Mortar present, no nail hole                |
| 0230 | 12 | 1204 | P | X   | 17  | 10  | 99  | 112 | 169 | 11 | Mortar present, nail hole top left          |
| 0231 | 12 | 1204 | X | X   | 10  | 8   | 75  | 110 | 186 | 12 | Mortar present, nail hole central           |
| 0232 | 12 | 1204 | X | N/A | N/A | N/A | 43  | 46  | 75  | 7  | Mortar present, nail hole top right, broken |
| 0233 | 12 | 1204 | P | X   | 9   | 13  | 121 | 125 | 163 | 13 | Mortar present, nail hole central           |
| 0234 | 12 | 1204 | X | N/A | N/A | N/A | 43  | 55  | 70  | 8  | Mortar present, no nail hole                |



|      |    |      |   |     |       |     |     |     |     |    |   |
|------|----|------|---|-----|-------|-----|-----|-----|-----|----|---|
| 0235 | 12 | 1204 | X | N/A | N/A   | N/A | 106 | 89  | 82  | 7  | Mortar present, no nail hole              |
| 0236 | 12 | 1204 | X | N/A | N/A   | N/A | 42  | 53  | 90  | 5  | Mortar present, no nail hole              |
| 0237 | 12 | 1204 | X | X   | N/A   | N/A | 54  | 60  | 107 | 8  | Mortar present, nail hole central, broken |
| 0238 | 12 | 1204 | X | N/A | N/A   | N/A | 50  | 12  | 24  | 6  | No mortar, no nail hole                   |
| 0239 | 12 | 1204 | X | X   | N/A   | N/A | 65  | 82  | 64  | 5  | No mortar, no nail hole                   |
| 0240 | 12 | 1204 | X | X   | N/A   | N/A | 70  | 117 | 155 | 12 | Mortar present, nail hole central, broken |
| 0241 | 12 | 1204 | X | N/A | N/A   | N/A | 65  | 102 | 117 | 9  | Mortar present, nail hole central, broken |
| 0242 | 12 | 1204 | X | N/A | 17    | 8   | 75  | 60  | 165 | 8  | Mortar present, nail hole central, broken |
| 0243 | 12 | 1206 | X | X   | N/A   | N/A | 63  | 114 | 270 | 11 | No mortar, no nail hole                   |
| 0244 | 12 | 1206 | P | X   | 14    | 6   | 107 | 110 | 233 | 10 | Mortar present, nail hole central         |
| 0245 | 12 | 1206 | X | P   | N/A   | N/A | 102 | 74  | 270 | 10 | No mortar, no nail hole                   |
| 0246 | 12 | 1206 | X | X   | N/A   | N/A | 110 | 95  | 138 | 17 | No mortar, nail hole central, broken      |
| 0247 | 12 | 1206 | X | N/A | 5     | 6   | 68  | 35  | 160 | 12 | No mortar, nail hole central, broken      |
| 0248 | 12 | 1206 | P | P   | 14    | 7   | 32  | 56  | 202 | 10 | No mortar, nail hole central, broken      |
| 0249 | 12 | 1206 | X | X   | N/A   | N/A | 75  | 46  | 150 | 8  | No mortar, no nail hole                   |
| 0250 | 12 | 1206 | X | X   | N/A   | N/A | 78  | 50  | 153 | 7  | No mortar, no nail hole                   |
| 0251 | 12 | 1206 | X | N/A | 22    | 3   | 73  | 96  | 100 | 11 | Mortar present, nail hole central         |
| 0252 | 12 | 1206 | X | N/A | N/A   | N/A | 30  | 49  | 109 | 8  | No mortar, no nail hole                   |
| 0253 | 12 | 1206 | X | N/A | N/A   | N/A | 83  | 89  | 104 | 16 | No mortar, no nail hole                   |
| 0254 | 12 | 1206 | X | N/A | N/A   | N/A | 67  | 181 | 162 | 12 | No mortar, no nail hole                   |
| 0255 | 12 | 1206 | X | N/A | 13    | 13  | 91  | 113 | 153 | 8  | No mortar, nail hole central, broken      |
| 0256 | 12 | 1206 | X | X   | 11    | 7   | 76  | 119 | 147 | 10 | No mortar, nail hole central, broken      |
| 0257 | 12 | 1206 | X | N/A | N/A   | N/A | 31  | 55  | 89  | 7  | No mortar, no nail hole                   |
| 0258 | 12 | 1206 | X | X   | N/A   | N/A | 42  | 63  | 171 | 10 | No mortar, no nail hole                   |
| 0259 | 12 | 1206 | X | N/A | N/A   | N/A | 104 | 53  | 107 | 5  | No mortar, no nail hole                   |
| 0260 | 12 | 1206 | P | X   | 12    | 7   | 83  | 110 | 164 | 8  | No mortar, nail hole central              |
| 0261 | 12 | 1206 | P | X   | 16/21 | 5/3 | 92  | 91  | 143 | 21 | No mortar, two nail holes top left        |
| 0262 | 12 | 1206 | P | X   | 20    | 5   | 70  | 94  | 175 | 15 | No mortar, nail hole top right            |
| 0263 | 12 | 1206 | X | X   | N/A   | N/A | 45  | 66  | 163 | 9  | No mortar, no nail hole                   |
| 0264 | 12 | 1206 | X | X   | 8     | 11  | 189 | 56  | 157 | 17 | Mortar present, nail hole central         |
| 0265 | 12 | 1206 | X | X   | 15    | 11  | 80  | 137 | 212 | 15 | Mortar present, nail hole central         |
| 0266 | 12 | 1206 | X | X   | 17    | 6   | 72  | 97  | 193 | 13 | No mortar, nail hole top left             |
| 0267 | 12 | 1206 | X | N/A | N/A   | N/A | 85  | 261 | 154 | 17 | Mortar present, no nail hole              |
| 0268 | 12 | 1207 | X | X   | 11    | 7   | 108 | 73  | 230 | 17 | Mortar present, nail hole central         |
| 0269 | 12 | 1207 | X | X   | N/A   | N/A | 75  | 151 | 260 | 7  | Mortar present, no nail hole              |
| 0270 | 12 | 1207 | P | X   | 18    | 8   | 98  | 104 | 194 | 19 | No mortar, nail hole central              |

|      |    |      |   |     |       |      |     |     |     |    |   |
|------|----|------|---|-----|-------|------|-----|-----|-----|----|---|
| 0271 | 12 | 1207 | X | X   | 12    | 12   | 132 | 164 | 165 | 13 | No mortar, nail hole top left             |
| 0272 | 12 | 1207 | X | N/A | 12    | 8    | 92  | 118 | 121 | 11 | No mortar, nail hole top left             |
| 0273 | 12 | 1207 | X | X   | 15    | 6    | 99  | 109 | 173 | 12 | No mortar, nail hole central              |
| 0274 | 12 | 1207 | X | X   | N/A   | N/A  | 120 | 129 | 145 | 10 | Mortar present, no nail hole              |
| 0275 | 12 | 1207 | X | X   | N/A   | N/A  | 70  | 80  | 160 | 10 | No mortar, no nail hole                   |
| 0276 | 12 | 1207 | X | N/A | N/A   | N/A  | 78  | 23  | 172 | 10 | No mortar, no nail hole                   |
| 0277 | 12 | 1207 | X | N/A | N/A   | N/A  | 62  | 82  | 157 | 12 | No mortar, no nail hole                   |
| 0278 | 12 | 1207 | X | N/A | N/A   | N/A  | 56  | 56  | 105 | 9  | No mortar, no nail hole                   |
| 0279 | 12 | 1207 | X | X   | N/A   | N/A  | 67  | 91  | 163 | 13 | Mortar present, no nail hole              |
| 0280 | 12 | 1207 | X | X   | N/A   | N/A  | 128 | 112 | 151 | 13 | Mortar present, nail hole top left broken |
| 0281 | 12 | 1207 | X | X   | N/A   | 8    | 118 | 130 | 126 | 10 | Mortar present, nail hole central broken  |
| 0282 | 12 | 1207 | X | N/A | N/A   | N/A  | 85  | 64  | 152 | 12 | No mortar, nail hole broken               |
| 0283 | 12 | 1207 | X | X   | N/A   | N/A  | 120 | 137 | 169 | 21 | Mortar present, no nail hole              |
| 0284 | 12 | 1207 | X | X   | N/A   | N/A  | 113 | 124 | 175 | 15 | Mortar present, no nail hole              |
| 0285 | 12 | 1207 | X | X   | N/A   | N/A  | 91  | 112 | 175 | 11 | No mortar, no nail hole                   |
| 0286 | 12 | 1207 | X | X   | N/A   | N/A  | 82  | 59  | 121 | 10 | No mortar, no nail hole                   |
| 0287 | 12 | 1207 | X | X   | N/A   | N/A  | 98  | 128 | 156 | 9  | No mortar, no nail hole                   |
| 0288 | 12 | 1207 | X | X   | N/A   | N/A  | 89  | 92  | 124 | 10 | No mortar, no nail hole                   |
| 0289 | 12 | 1207 | X | X   | N/A   | N/A  | 99  | 102 | 177 | 15 | Mortar present, no nail hole              |
| 0290 | 12 | 1207 | X | N/A | 15    | 6    | 50  | 81  | 110 | 11 | No mortar, nail hole central              |
| 0291 | 12 | 1207 | X | N/A | N/A   | N/A  | 83  | 110 | 156 | 10 | Mortar present, no nail hole              |
| 0292 | 12 | 1214 | X | X   | N/A   | N/A  | 77  | 75  | 146 | 4  | No mortar, no nail hole                   |
| 0293 | 12 | 1214 | X | X   | N/A   | N/A  | 86  | 123 | 172 | 10 | No mortar, no nail hole                   |
| 0294 | 12 | 1214 | X | N/A | N/A   | N/A  | 177 | 50  | 167 | 11 | No mortar, no nail hole                   |
| 0295 | 12 | 1214 | X | N/A | 11    | 7    | 82  | 123 | 163 | 15 | No mortar, nail hole central              |
| 0296 | 12 | 1214 | X | N/A | N/A   | N/A  | 72  | 145 | 223 | 12 | No mortar, no nail hole                   |
| 0297 | 12 | 1214 | X | N/A | 12    | 9    | 116 | 100 | 155 | 6  | No mortar, nail hole central              |
| 0298 | 12 | 1214 | X | N/A | N/A   | N/A  | 45  | 50  | 82  | 11 | No mortar, no nail hole                   |
| 0299 | 12 | 1214 | X | N/A | 12    | 7    | 112 | 103 | 149 | 7  | No mortar, nail hole top right            |
| 0300 | 12 | 1214 | X | N/A | N/A   | N/A  | 63  | 55  | 122 | 16 | No mortar, no nail hole                   |
| 0301 | 12 | 1214 | X | N/A | N/A   | N/A  | 62  | 34  | 98  | 7  | No mortar, no nail hole                   |
| 0302 | 9a | 926  | X | N/A | N/A   | N/A  | 67  | 82  | 188 | 17 | Mortar present, no nail hole              |
| 0303 | 9a | 926  | X | N/A | 5     | 7    | 63  | 68  | 90  | 7  | No mortar                                 |
| 0304 | 9a | 931  | X | N/A | N/A   | N/A  | 109 | 129 | 144 | 9  | No mortar, no nail hole                   |
| 0305 | 9a | 931  | X | N/A | 16/27 | 10/9 | 73  | 86  | 65  | 7  | No mortar, two nail holes                 |
| 0306 | 10 | 1003 | X | N/A | N/A   | N/A  | 61  | 203 | 213 | 12 | Mortar present, nail hole central, broken |

|      |    |      |   |     |     |     |     |     |     |    |   |
|------|----|------|---|-----|-----|-----|-----|-----|-----|----|---|
| 0307 | 10 | 1003 | X | N/A | N/A | N/A | 90  | 105 | 173 | 15 | Mortar present, nail hole central, broken |
| 0308 | 23 | 2313 | X | N/A | 20  | 7   | 68  | 77  | 100 | 10 | No mortar, nail hole top right            |
| 0309 | 23 | 2313 | X | N/A | N/A | N/A | 55  | 51  | 97  | 10 | No mortar, no nail hole                   |
| 0310 | 23 | 2313 | X | N/A | N/A | N/A | 104 | 100 | 131 | 12 | No mortar, no nail hole                   |
| 0311 | 23 | 2313 | X | N/A | N/A | N/A | 63  | 62  | 81  | 8  | No mortar, no nail hole                   |
| 0312 | 23 | 2313 | X | N/A | N/A | N/A | 95  | 70  | 130 | 8  | No mortar, nail hole central, broken      |
| 0313 | 23 | 2313 | P | N/A | 8   | 9   | 71  | 102 | 156 | 11 | No mortar, nail hole top right            |
| 0314 | 23 | 2313 | X | N/A | N/A | N/A | 73  | 94  | 99  | 10 | No mortar, no nail hole                   |
| 0315 | 23 | 2313 | X | N/A | N/A | N/A | 74  | 77  | 140 | 12 | No mortar, no nail hole                   |
| 0316 | 23 | 2313 | X | N/A | N/A | N/A | 80  | 71  | 120 | 14 | Mortar present, no nail hole              |
| 0317 | 23 | 2313 | X | N/A | N/A | N/A | 52  | 49  | 115 | 18 | Mortar present, no nail hole              |
| 0318 | 23 | 2313 | X | N/A | N/A | N/A | 57  | 36  | 115 | 10 | Mortar present, no nail hole              |
| 0319 | 23 | 2313 | X | N/A | N/A | N/A | 57  | 72  | 94  | 11 | No mortar, no nail hole                   |
| 0320 | 23 | 2313 | X | N/A | N/A | N/A | 79  | 76  | 94  | 12 | No mortar, no nail hole                   |
| 0321 | 7  | 701  | P | X   | 14  | 9   | 122 | 102 | 170 | 6  | No mortar, nail hole central              |
| 0322 | 7  | 701  | P | X   | 17  | 6   | 118 | 127 | 175 | 10 | No mortar, nail hole top left             |
| 0323 | 7  | 701  | P | X   | 14  | 10  | 94  | 152 | 170 | 11 | No mortar, nail hole central              |
| 0324 | 7  | 701  | X | X   | N/A | N/A | 110 | 114 | 125 | 10 | No mortar, no nail hole                   |
| 0325 | 7  | 701  | X | X   | N/A | N/A | 82  | 87  | 166 | 8  | No mortar, nail hole central, broken      |
| 0326 | 7  | 701  | X | N/A | N/A | N/A | 87  | 59  | 161 | 15 | No mortar, nail hole central, broken      |
| 0327 | 7  | 701  | X | X   | 9   | 8   | 92  | 178 | 215 | 12 | No mortar, nail hole top right            |
| 0328 | 7  | 701  | X | N/A | N/A | N/A | 84  | 48  | 142 | 10 | No mortar, nail hole top right, broken    |
| 0329 | 7  | 701  | X | X   | N/A | N/A | 91  | 125 | 164 | 8  | No mortar, nail hole central, broken      |
| 0330 | 7  | 701  | X | X   | 17  | 5   | 114 | 126 | 172 | 10 | No mortar, nail hole top right            |
| 0331 | 7  | 701  | X | X   | 14  | 7   | 81  | 99  | 166 | 9  | No mortar, nail hole central              |
| 0332 | 7  | 701  | P | X   | 14  | 8   | 105 | 119 | 165 | 14 | No mortar, nail hole top left             |
| 0333 | 7  | 701  | X | X   | N/A | N/A | 141 | 155 | 260 | 8  | No mortar, no nail hole                   |
| 0334 | 7  | 701  | X | X   | 14  | 9   | 94  | 79  | 286 | 9  | No mortar, nail hole central              |
| 0335 | 8  | 803  | X | X   | N/A | N/A | 83  | 136 | 150 | 15 | No mortar, nail hole central              |
| 0336 | 8  | 803  | X | X   | 12  | 8   | 143 | 148 | 168 | 13 | No mortar, nail hole top right            |
| 0337 | 8  | 803  | P | X   | 7   | 4   | 135 | 144 | 160 | 12 | No mortar, nail hole central              |
| 0338 | 8  | 803  | P | X   | 18  | 6   | 92  | 109 | 167 | 6  | No mortar, nail hole top left             |
| 0339 | 8  | 803  | X | X   | 10  | 7   | 90  | 101 | 192 | 12 | No mortar, nail hole central              |
| 0340 | 8  | 803  | P | X   | 21  | 6   | 131 | 140 | 177 | 15 | No mortar, nail hole top right            |
| 0341 | 8  | 803  | X | X   | 12  | 8   | 93  | 123 | 165 | 12 | Mortar present, nail hole central         |